

Center wing strut ar  
(Make 2)

gear strut angle guage  
(Make 1)

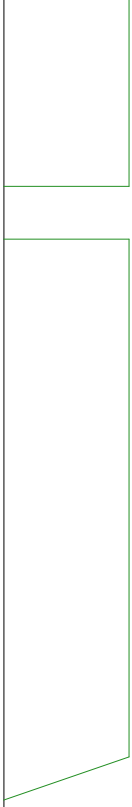

Cut slot for 0.125" dia x  
carbon tube axle

Landing gear win  
(Make 2, laminate  
and sand to airfoil sh

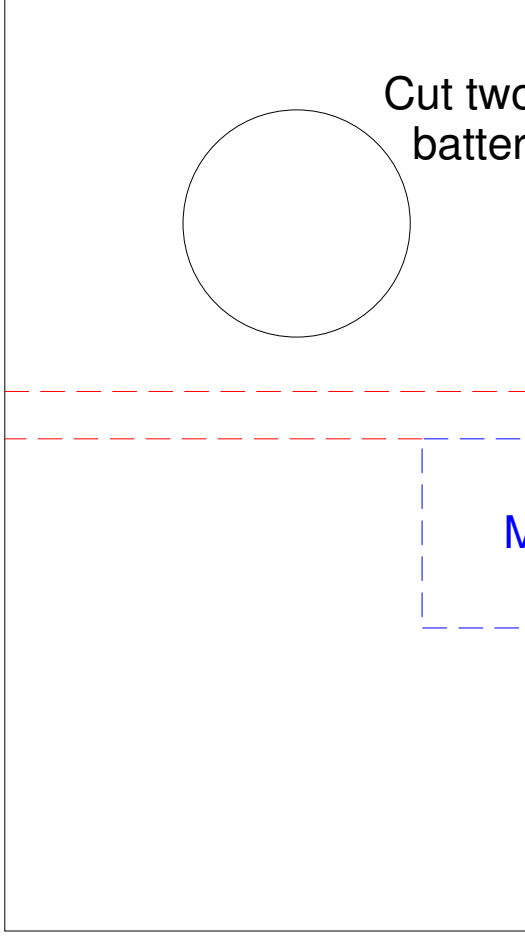

Cut two batter

M

holes for  
cooling

**F-1**

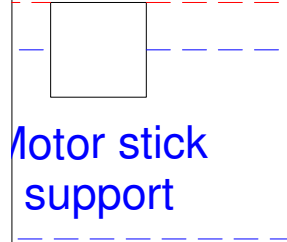
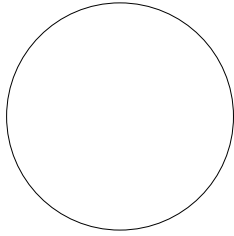

Motor stick  
support

Side support/  
battery tray

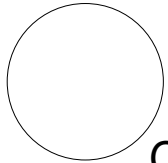

Cut hole for  
motor wires

Cut two holes for  
battery cooling and  
wiring access

**F-2**

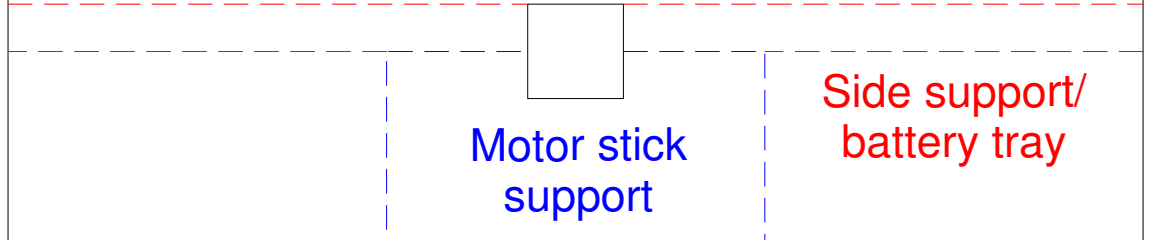
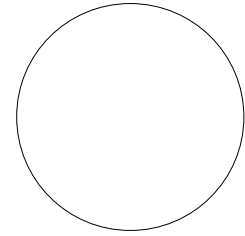
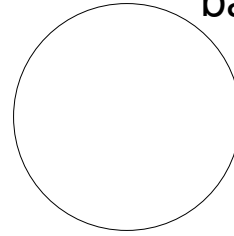

Motor stick  
support

Side support/  
battery tray

**F-3**

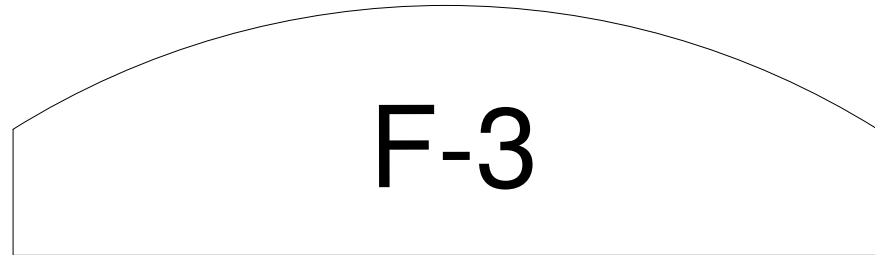

Motor stick side supports/  
battery tray  
(Make 2)

# F-4

Hole for elevator pushrod



Slot for rudder threads



Cut  
lightening  
hole

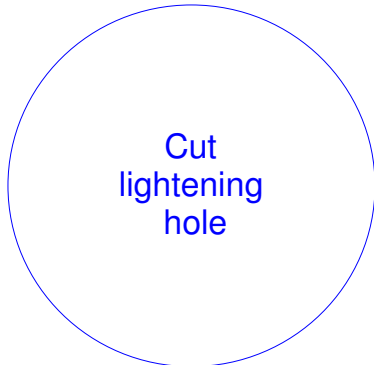

Fwd wing strut doubler  
(Make 2)

Aft landing  
aft wing strut  
(Make

Fwd landing gear  
strut doubler  
(Make 2)

gear/  
doubler  
4)

Wheels used on  
prototype (for 3.0" O.D.  
O-rings) (Make 2)

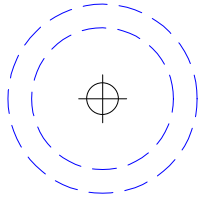

2.75" dia.

Wheel hubs  
(Make 2 each  
from 1/32" ply)

Inboard

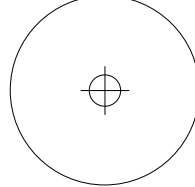

3/4" dia.

Outboard

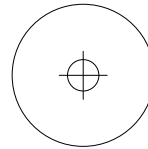

9/16" dia.

Drill all wheel hubs for  
1/8" dia. carbon tube axle

Wheel axle stop  
(Make 2 from  
1/8" lite-ply)

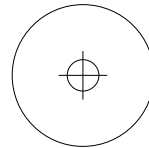

9/16" dia.

Optional scale wheels  
(for 3.5" O.D. O-rings)  
(Make 2)

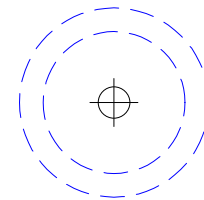

3.25" dia.



Fwd fuselage bottom  
(Make 1)

ngle guage

Base cross piece for  
all alignment guages  
(Make 2)

Upper wing alignment gu  
(Make 2)

Landing

age

Center wing struts  
(Make 2 from 1/8" lite ply)

Landing  
(Make 2 from



8.75"

ing  
e,  
ape)

2nd lay  
(M

Mot



er of cowling  
(Make 1)

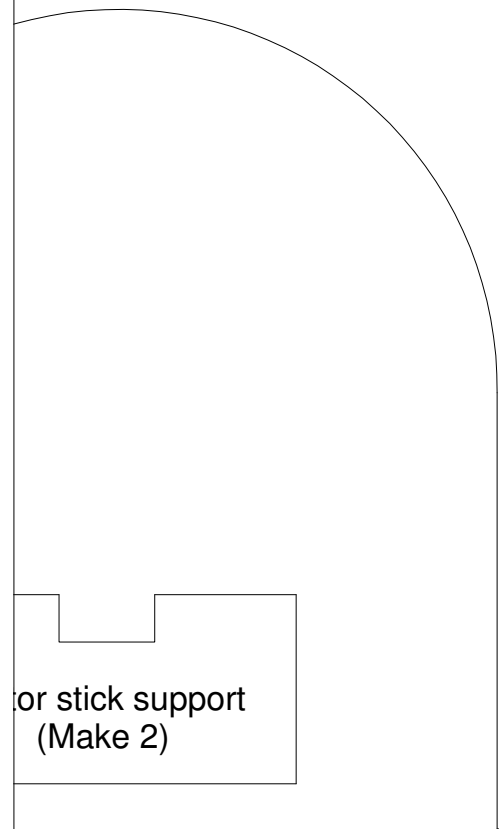

or stick support  
(Make 2)

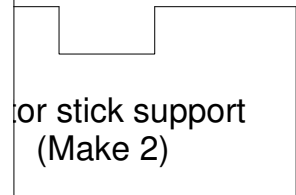

Inner layers of cowling  
(Make 7)

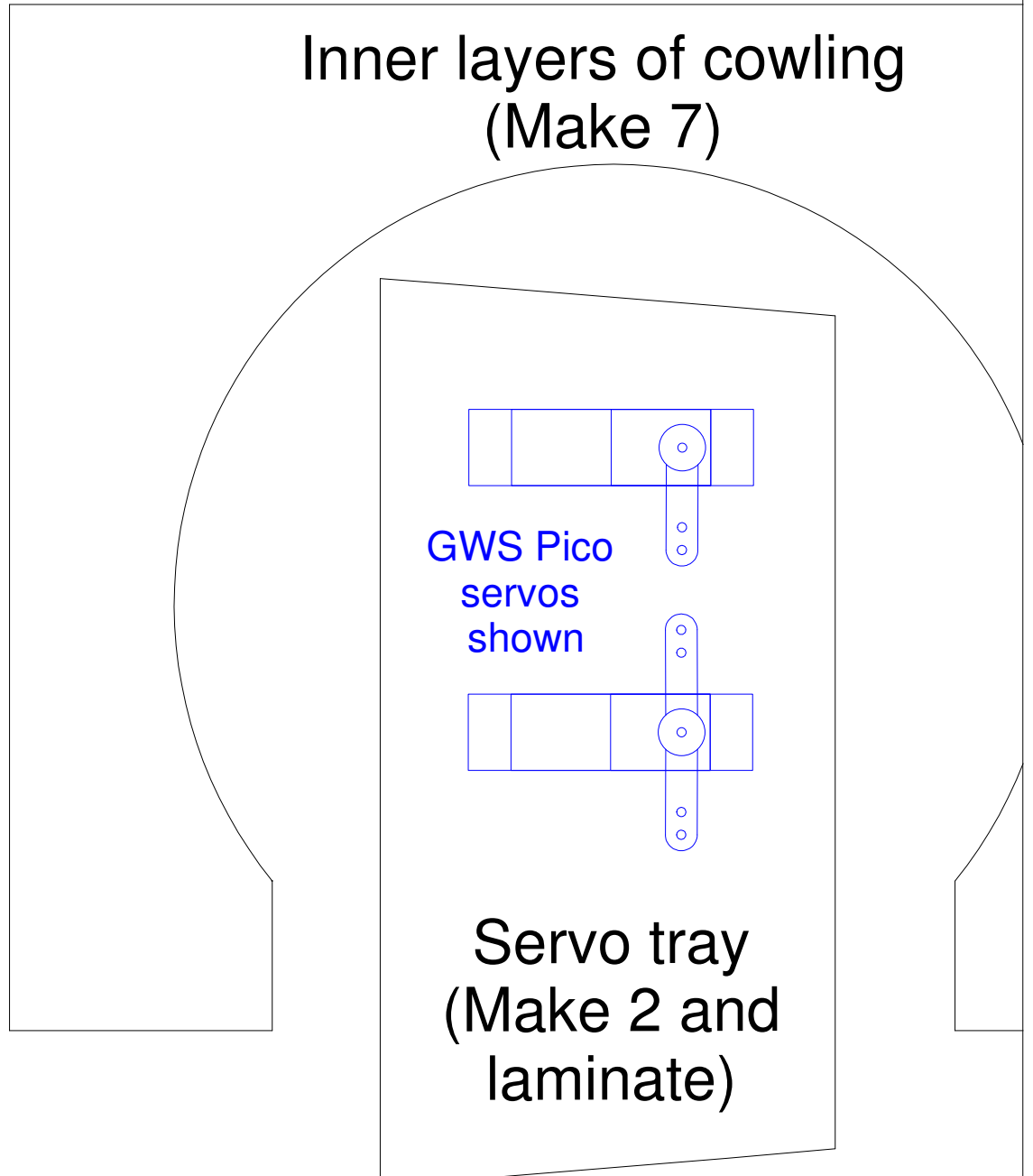

GWS Pico  
servos  
shown

Servo tray  
(Make 2 and  
laminates)

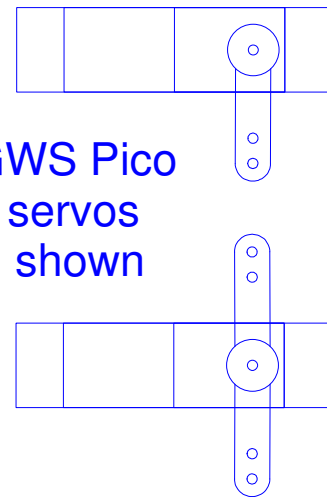

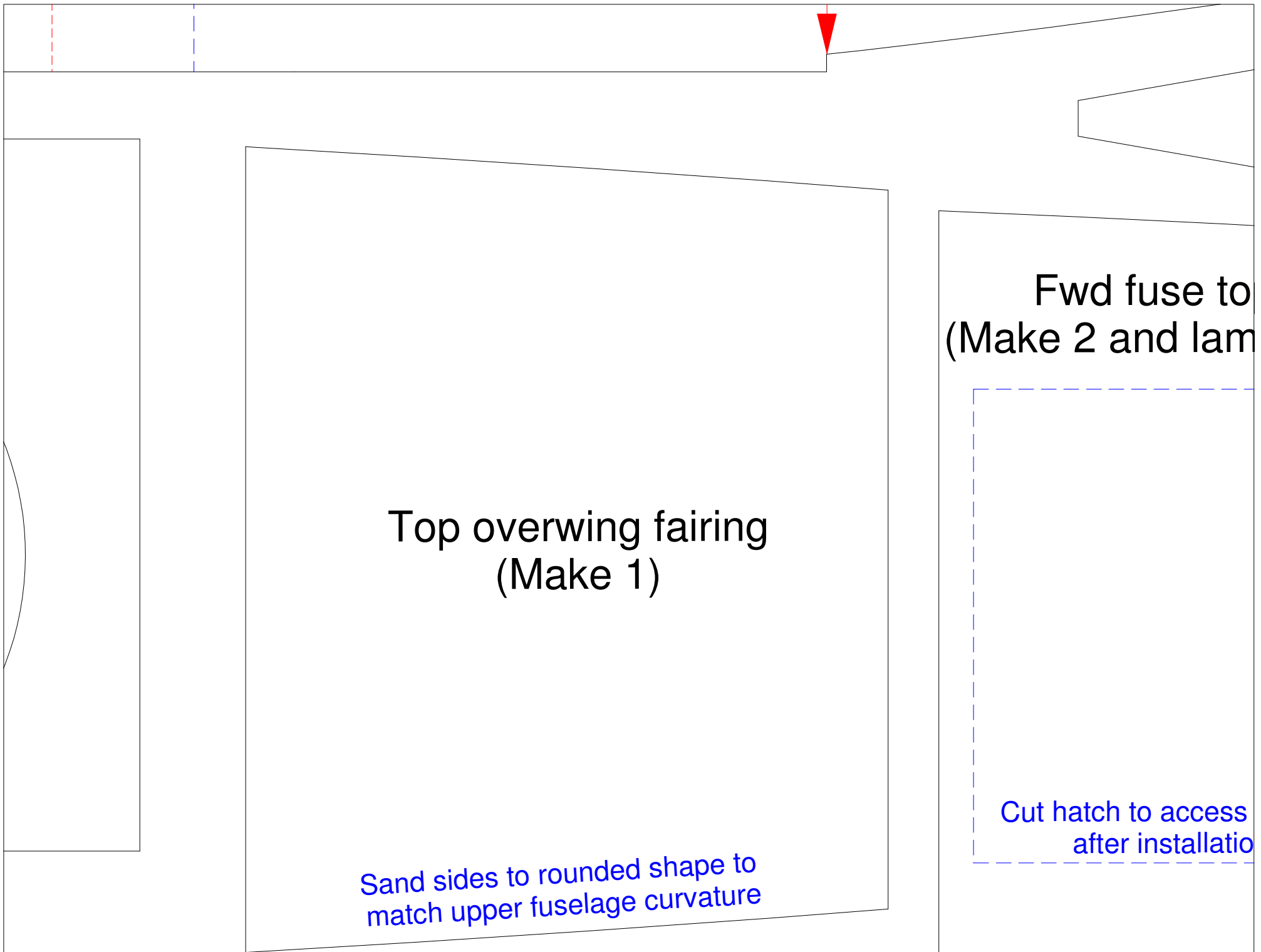

Top overwing fairing  
(Make 1)

Fwd fuse to  
(Make 2 and lam

Cut hatch to access  
after installio

Sand sides to rounded shape to  
match upper fuselage curvature

p  
minate)

battery  
n

Cut cockpit hole  
AFTER installing  
turtledeck top

Turtledeck t  
(Make 1 from 3mm

Aft fuselage bottom  
(Make 1 from 3mm Depron)

op  
(Make 1 from 3mm Depron)

Turtledeck/  
stabilizer  
trim piece  
(Make 1 from  
3mm Depron)

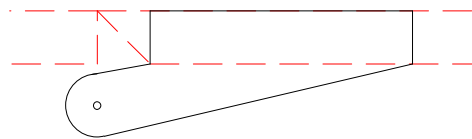

Elevator control horns  
(Make 1 from 1/32" ply)

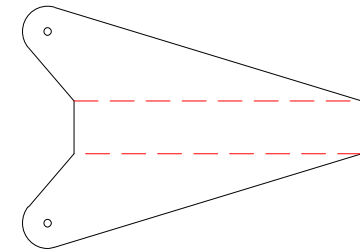

Rudder control horn  
(for pull-pull threads)  
(Make 1 from 1/32" ply)

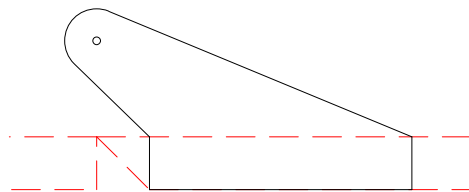

Aileron control horns  
(Make 2 from 1/32" ply)



Aileron connectors  
(Make 6 from 1/32" ply)

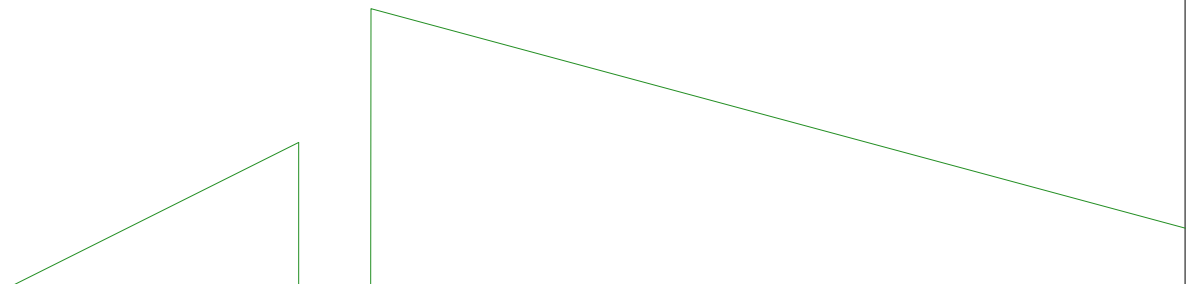

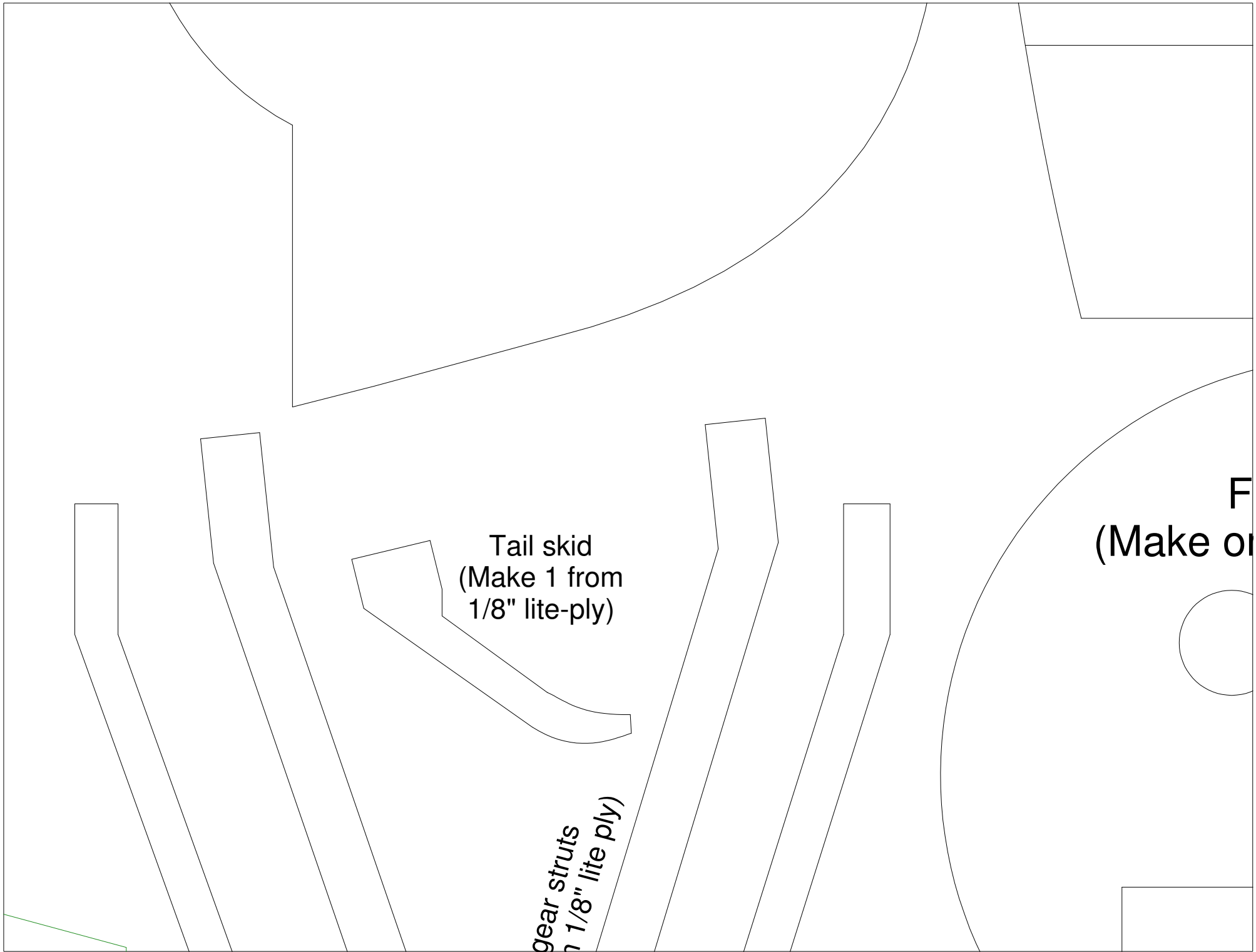

Tail skid  
(Make 1 from  
1/8" lite-ply)

Gear struts  
(1/8" lite ply)

F  
(Make on

Front of cowling  
(made from 3mm Depron)

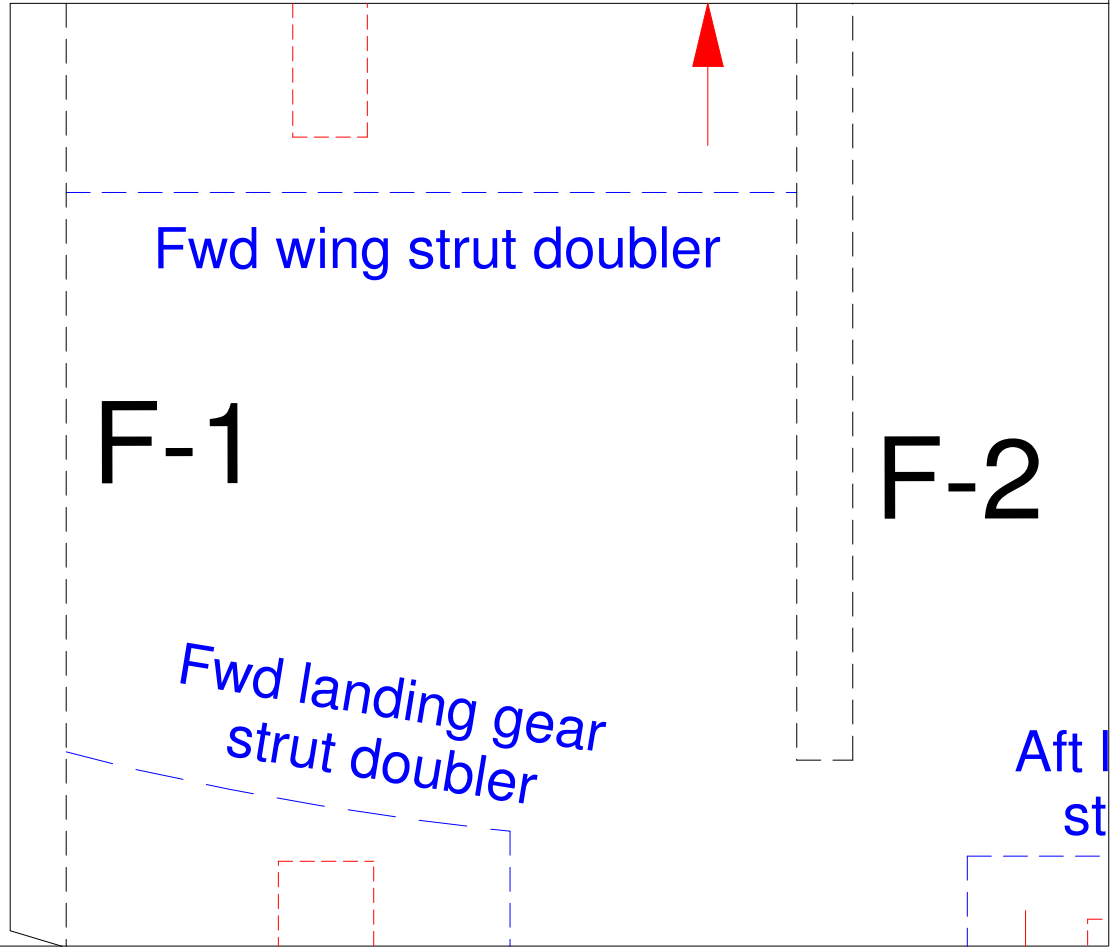
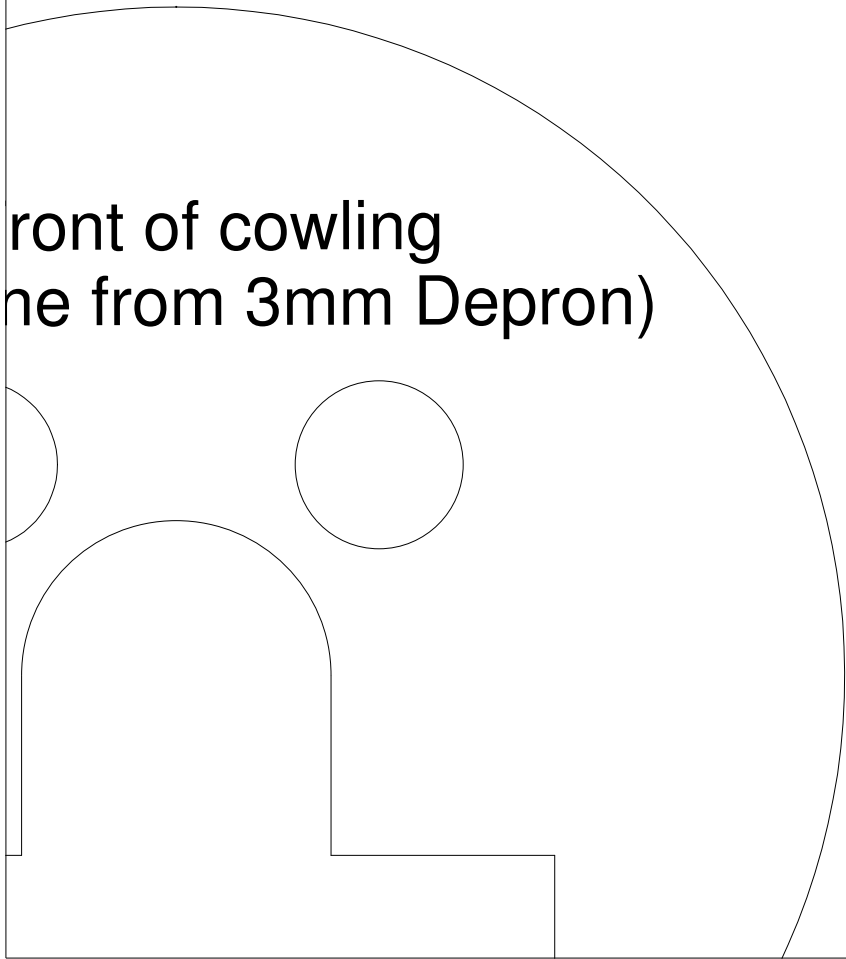

Cut access hatch  
for receiver

Aft wing strut doubler

F-3

Servo tray location

Fuselage sides  
(Make 2)

Landing gear  
strut doubler

Wing alignment marks



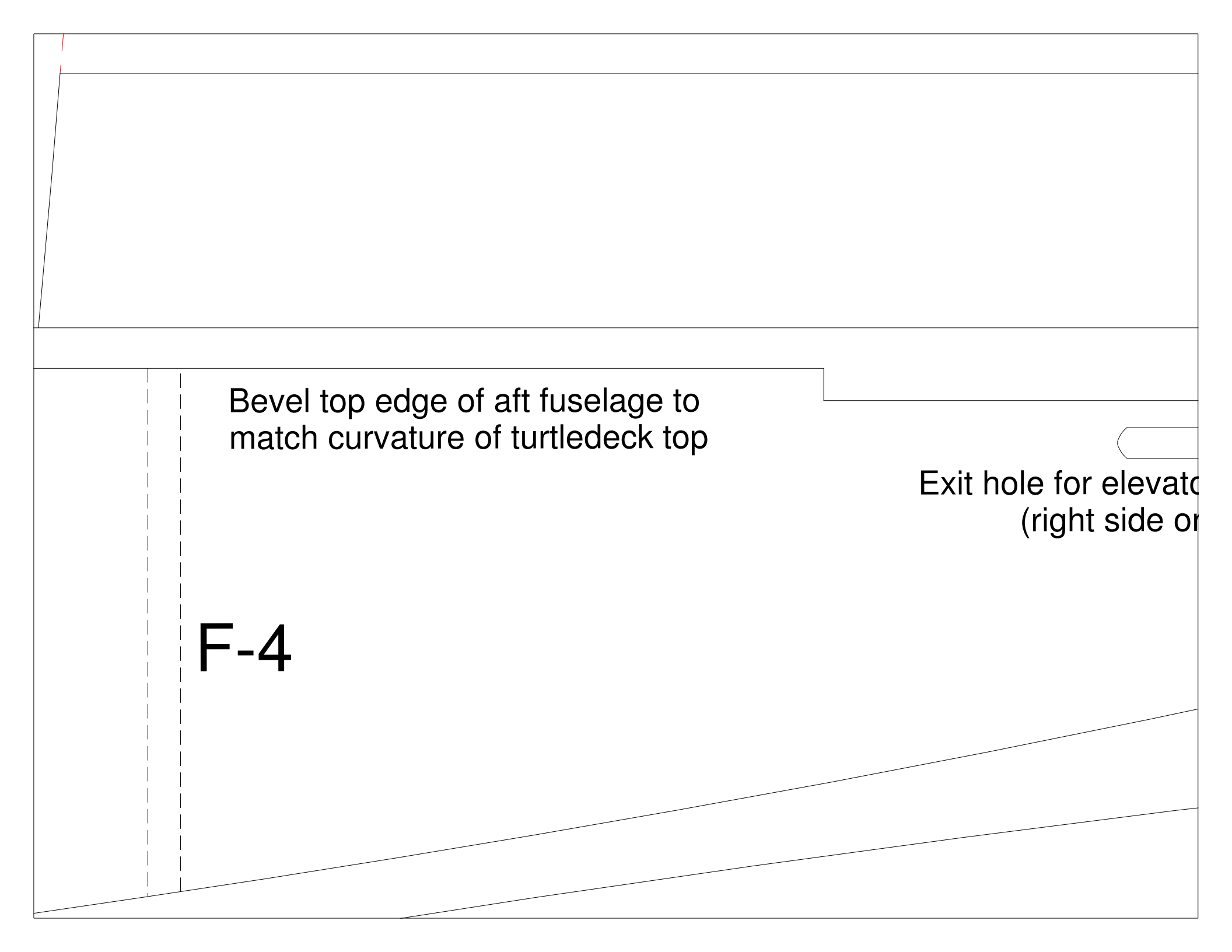

Bevel top edge of aft fuselage to  
match curvature of turtledeck top

The diagram shows a cross-section of an aircraft fuselage. At the top, there is a horizontal line representing the turtledeck top. Below it, the fuselage structure is shown with a beveled top edge on the right side. Two vertical dashed lines are drawn on the left side of the fuselage. On the right side, there is a rectangular cutout with a semi-circular end, representing an exit hole. The text 'Bevel top edge of aft fuselage to match curvature of turtledeck top' is positioned above the fuselage structure. The text 'Exit hole for elevator (right side of fuselage)' is positioned to the right of the cutout. The text 'F-4' is positioned to the left of the fuselage structure.

Exit hole for elevator  
(right side of fuselage)

**F-4**

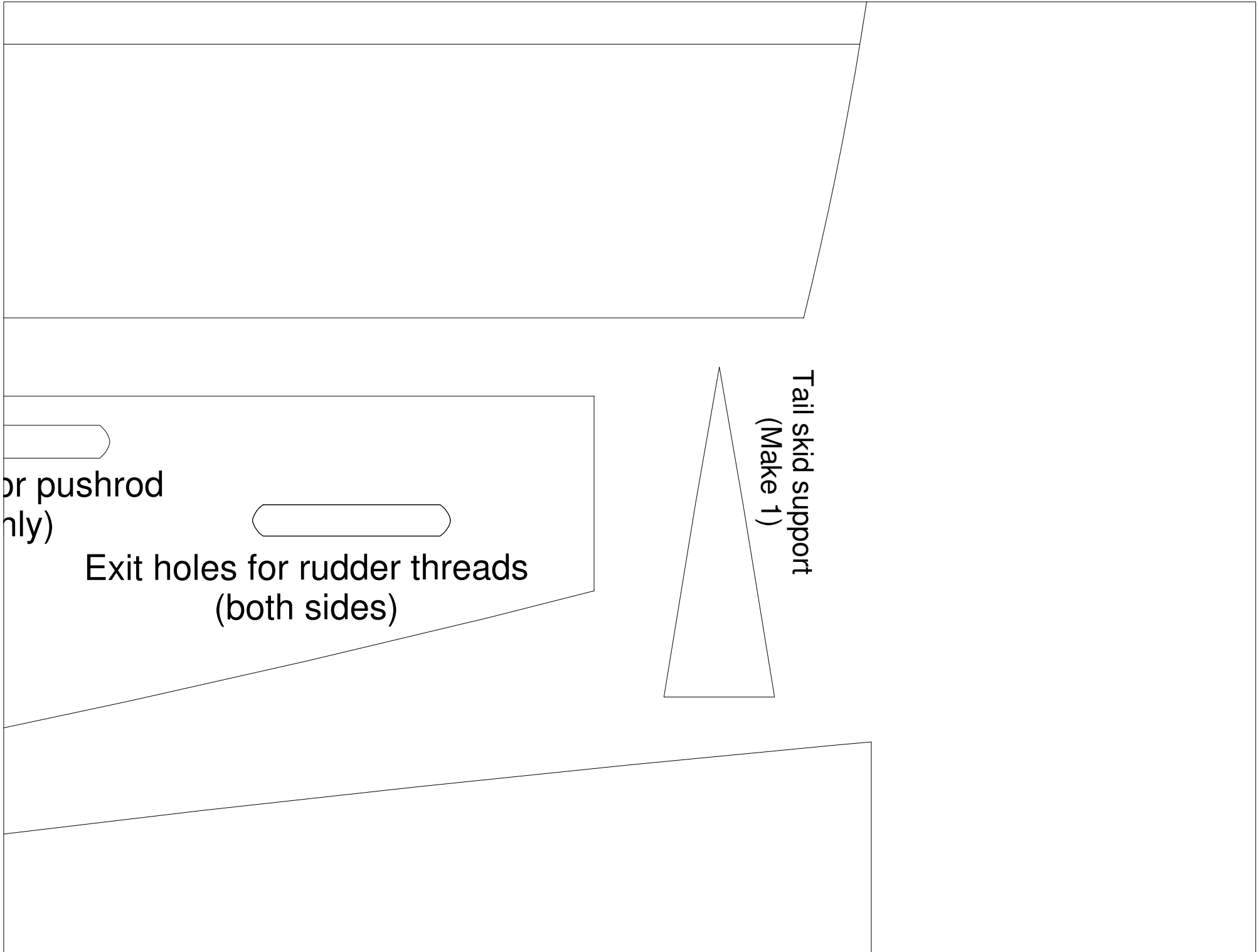

or pushrod  
(only)

Exit holes for rudder threads  
(both sides)

Tail skid support  
(Make 1)

quare hardwood joiner  
degrees on leading edge)



Vertical tail  
(Make 1)

Horizontal tail  
(Make 1)



c

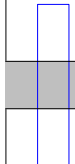

Cut slot to  
fit wind struts

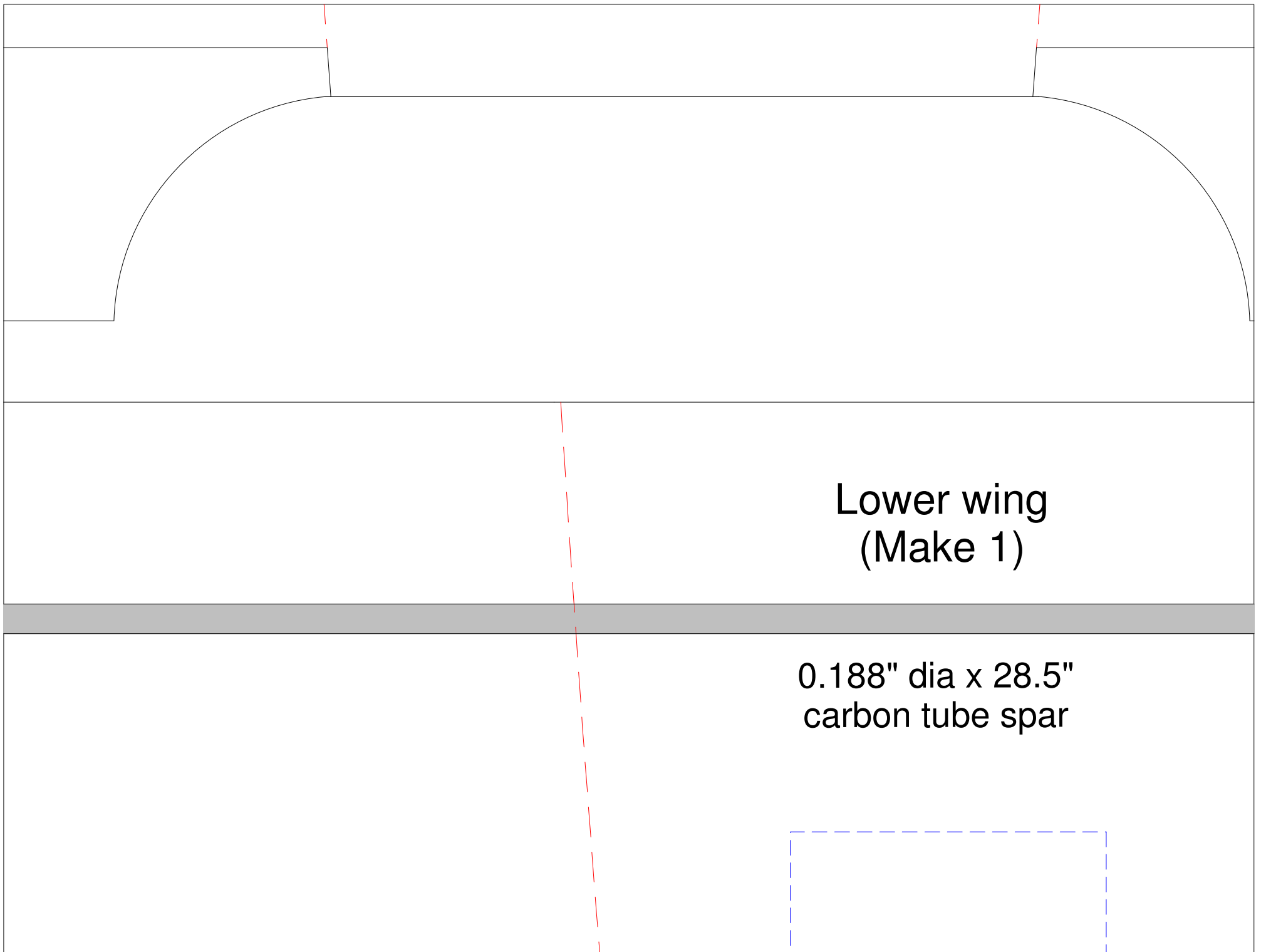

Lower wing  
(Make 1)

0.188" dia x 28.5"  
carbon tube spar

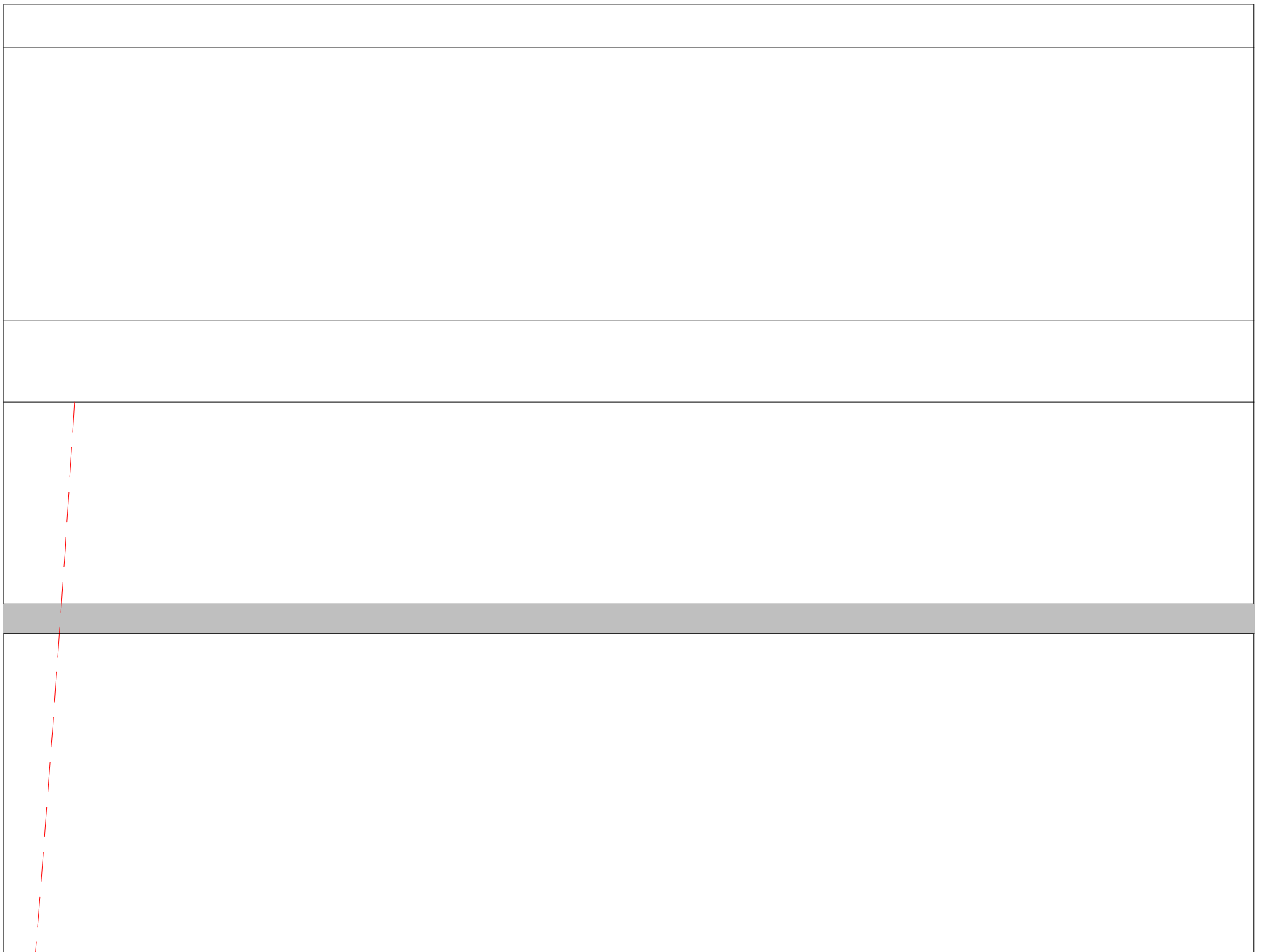

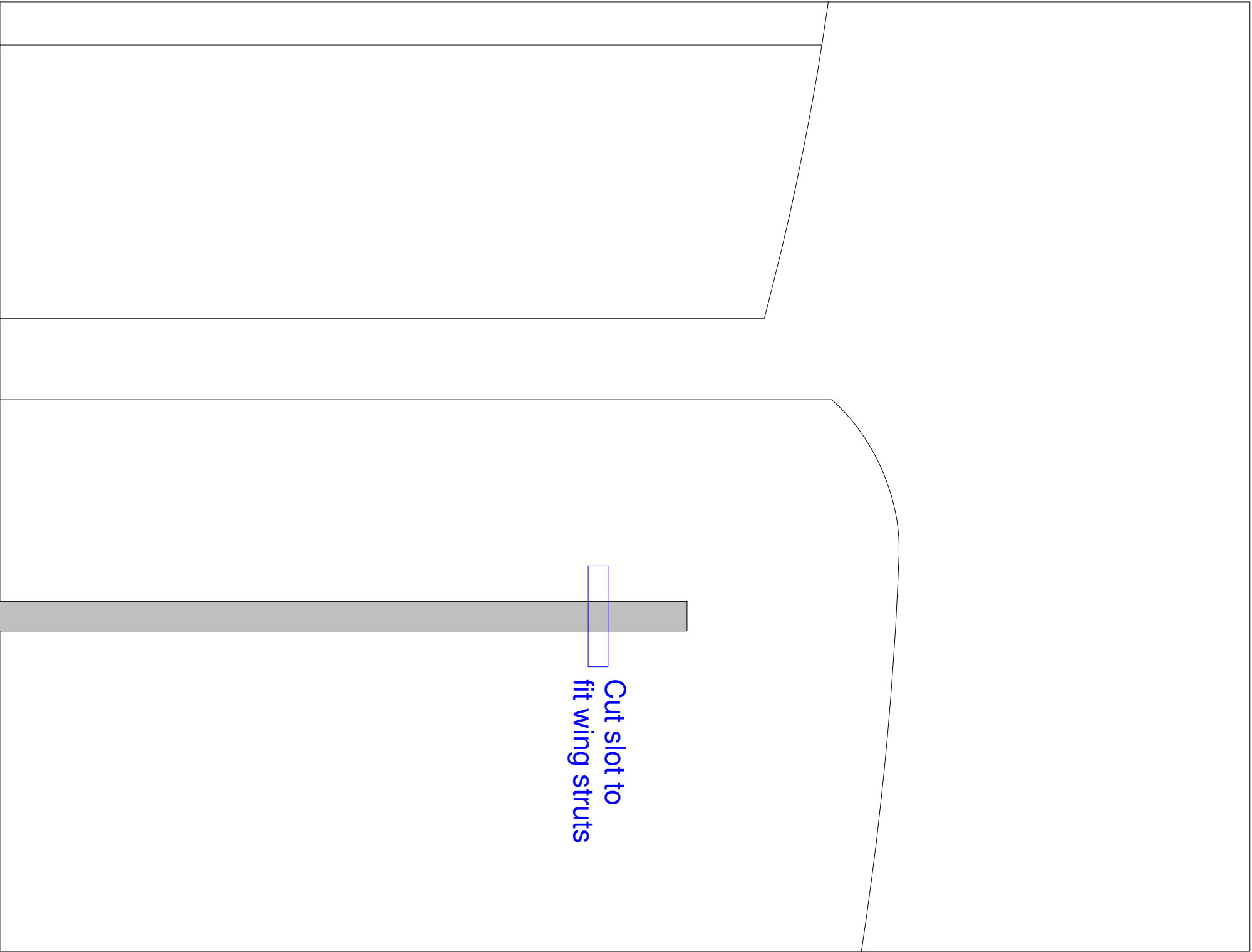

Cut slot to  
fit wing struts



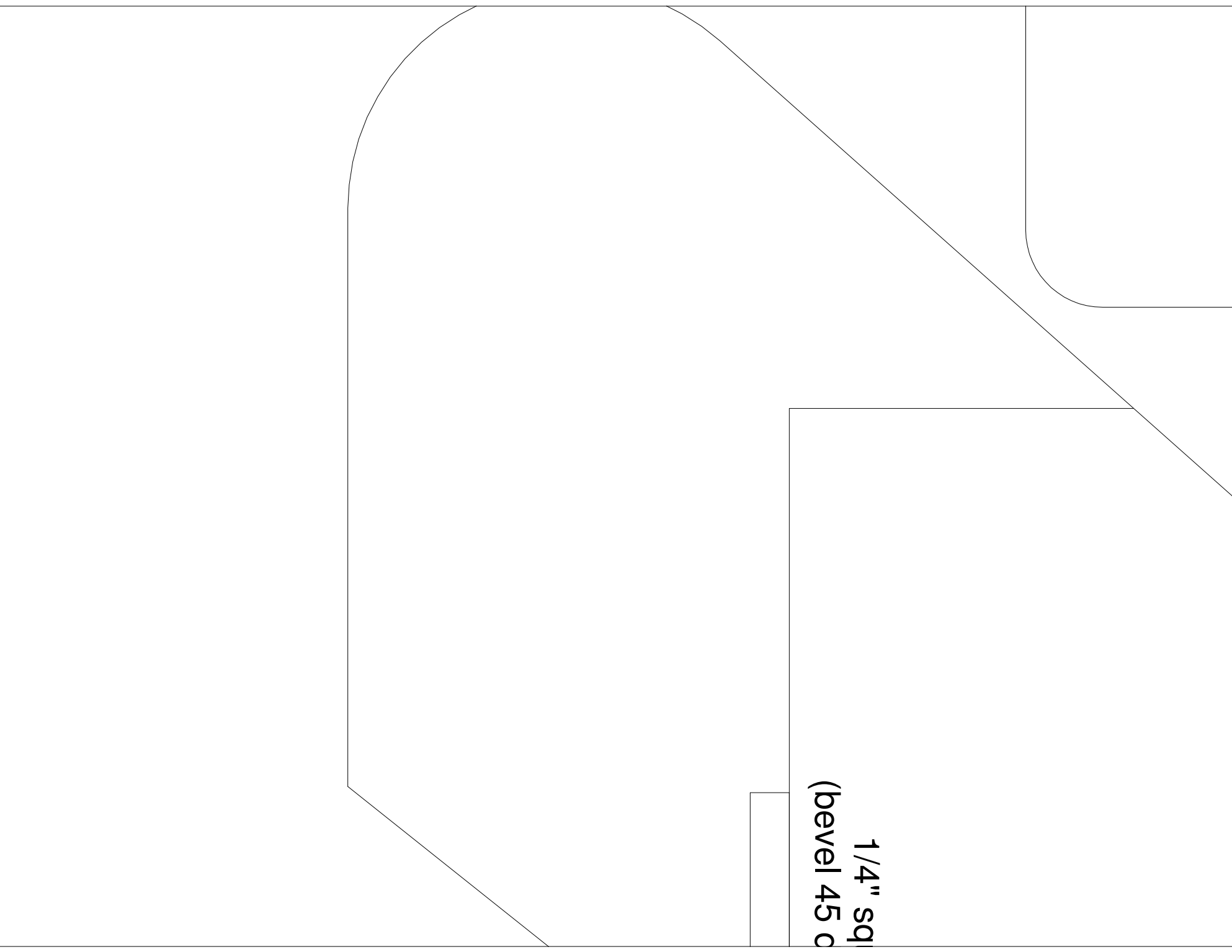

1/4" sq  
(bevel 45°)

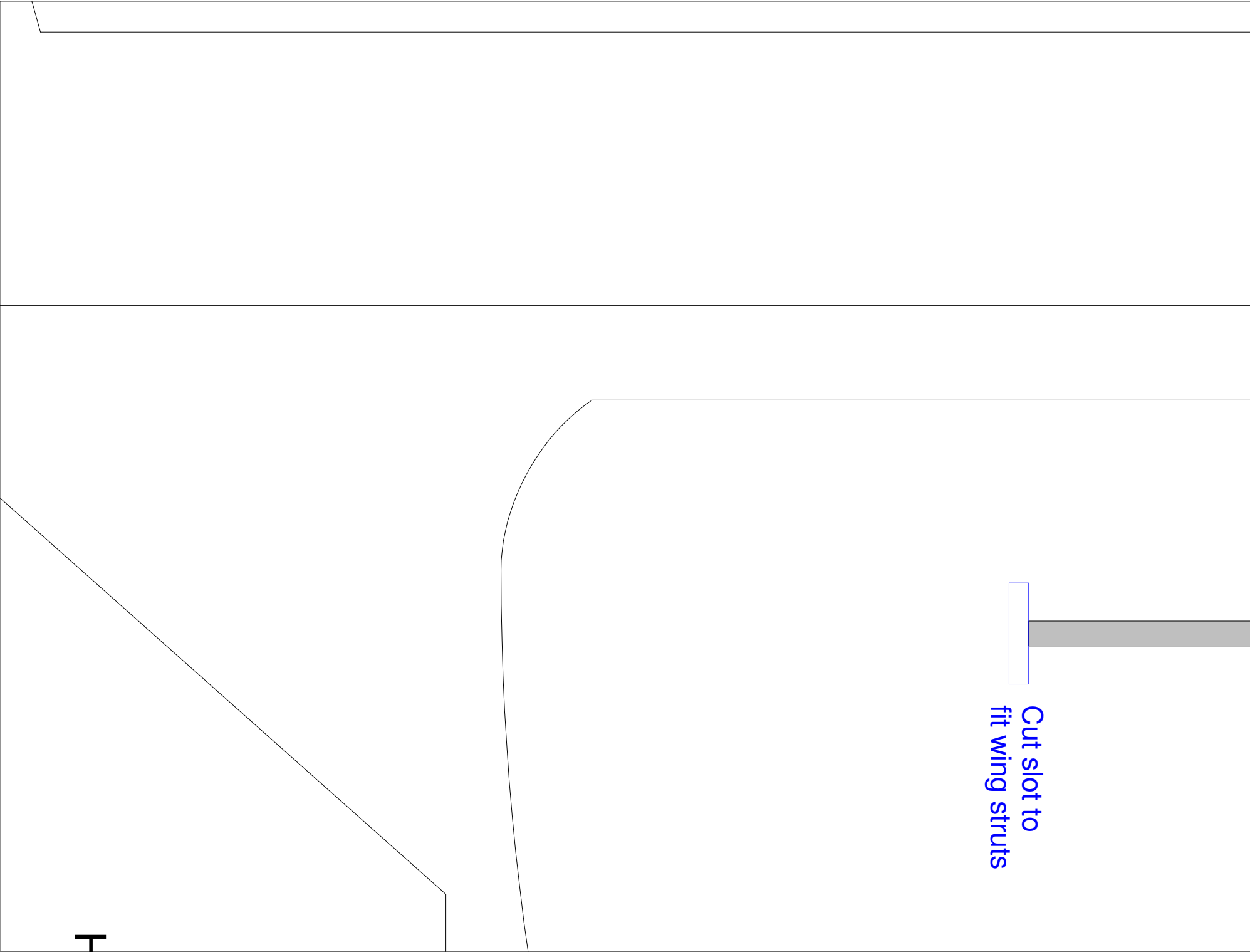

Cut slot to  
fit wing struts

T

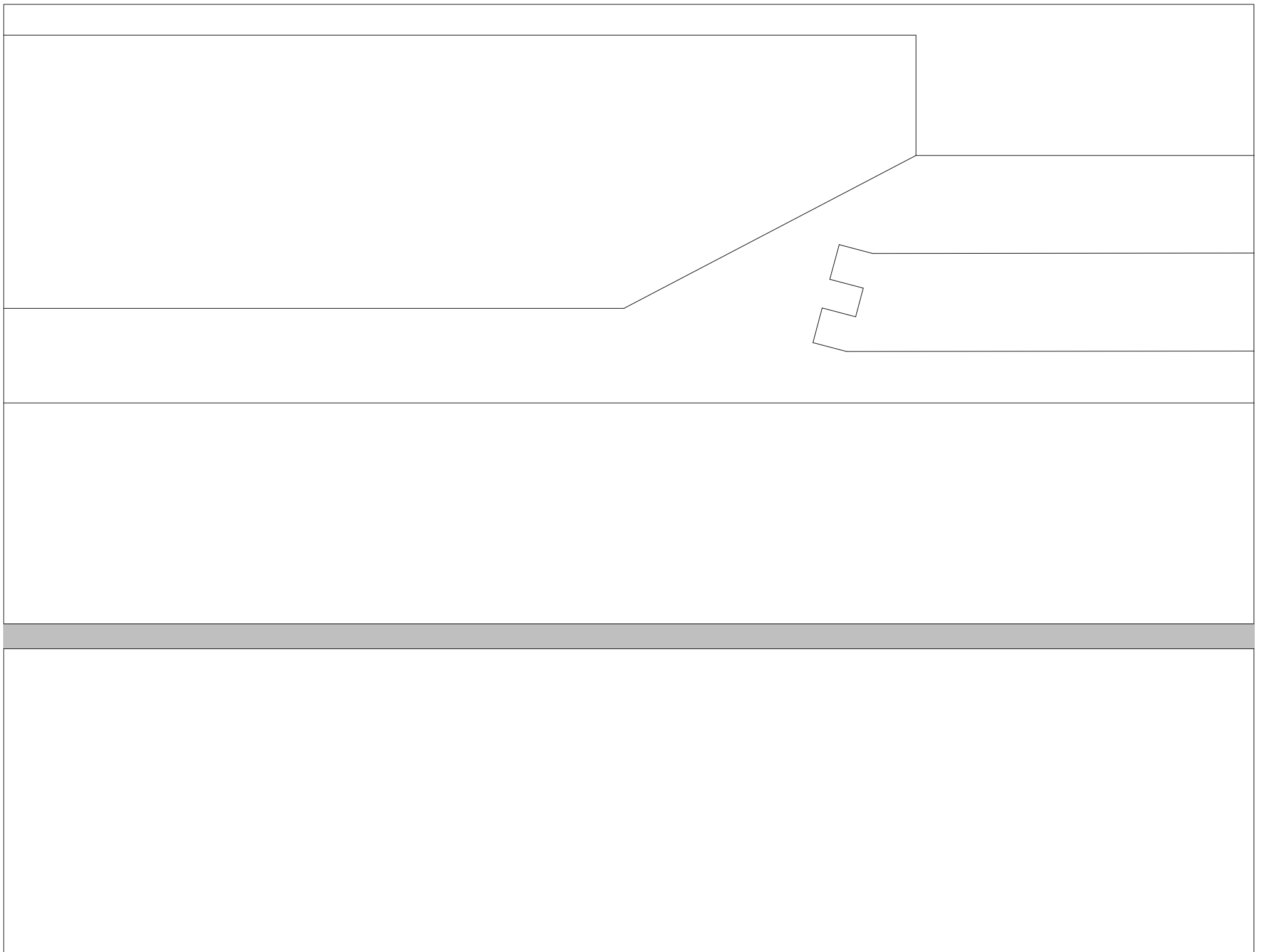

Main wing struts  
(Make 2 from 1/8" lite-ply)

Middle wing  
(Make 1)

1.3"



0.157" dia x 27.2"  
carbon tube spar

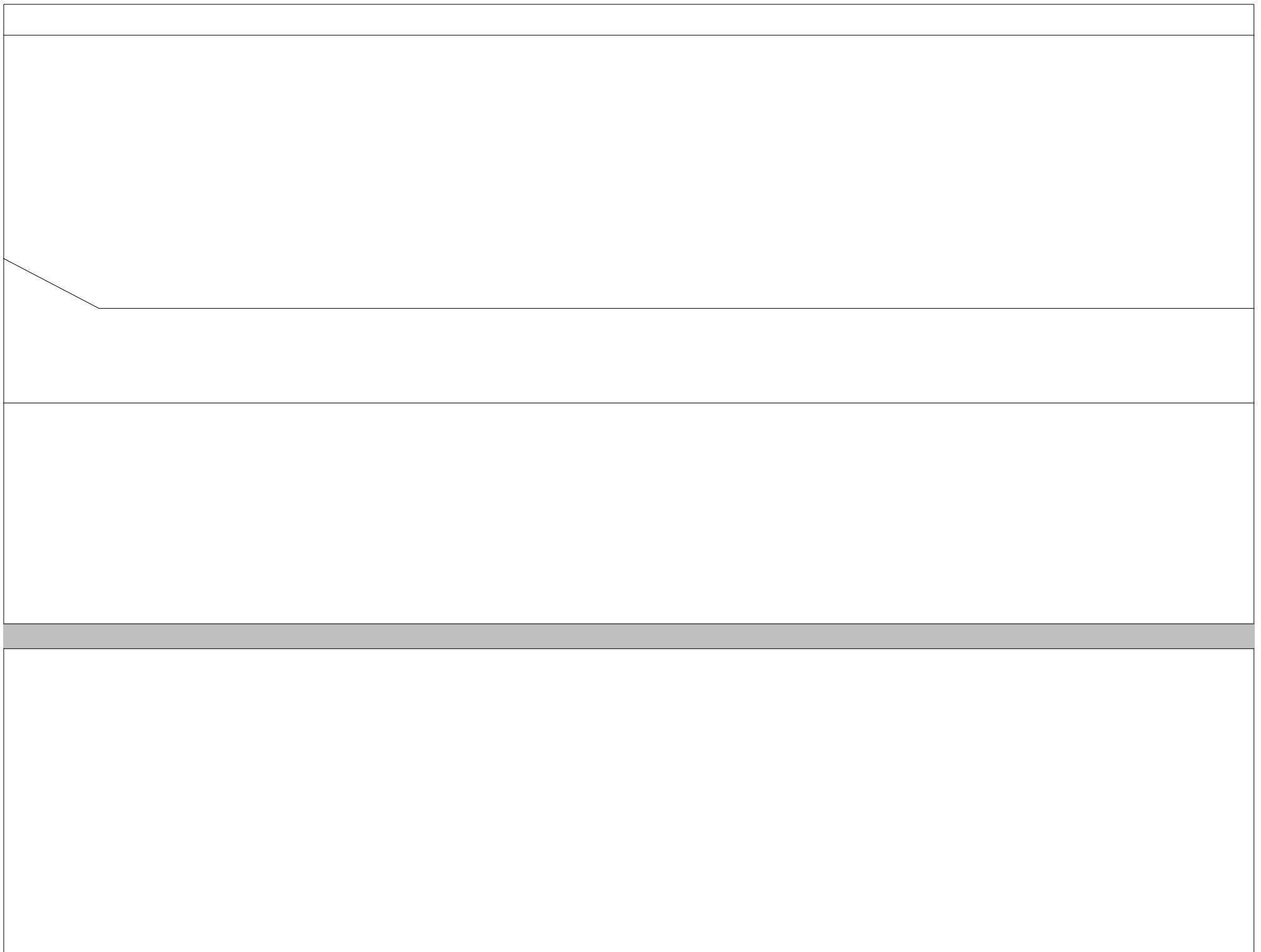

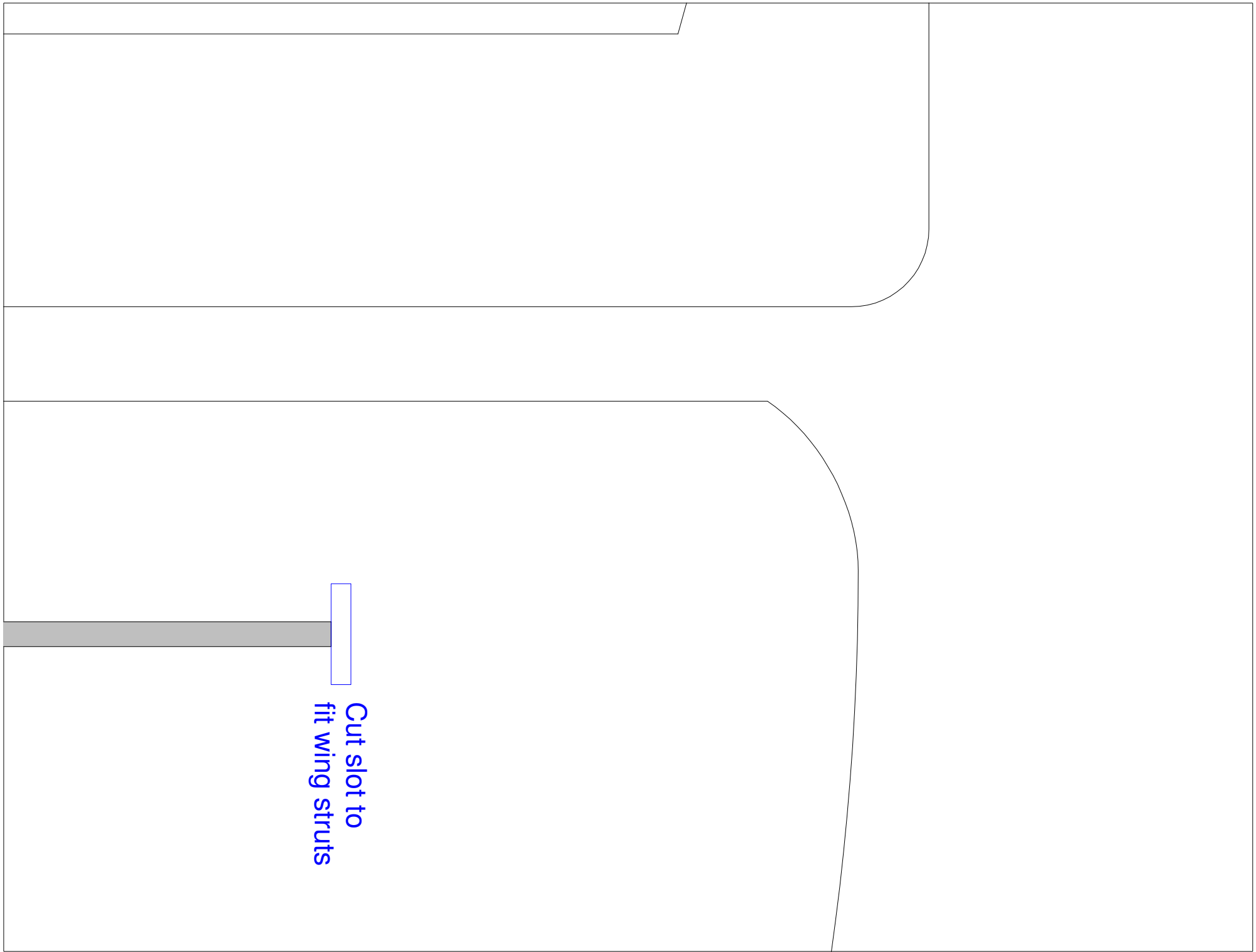

Cut slot to  
fit wing struts

# ***Fokker DR1 Parkflyer***

***Designed by Steve Shumate***  
***Copyright © 2005 All Rights Reserved***

**All parts are made from 6 mm Depron or  
BlueCore foam unless otherwise specified**

***If you enjoy these plans, please consider sending a small contribution to the designer to show your appreciation for the work that went into them. Suggested contribution is \$5 to \$10 U.S., and can be sent via PayPal to [jetset44@verizon.net](mailto:jetset44@verizon.net). Thanks for your support!***

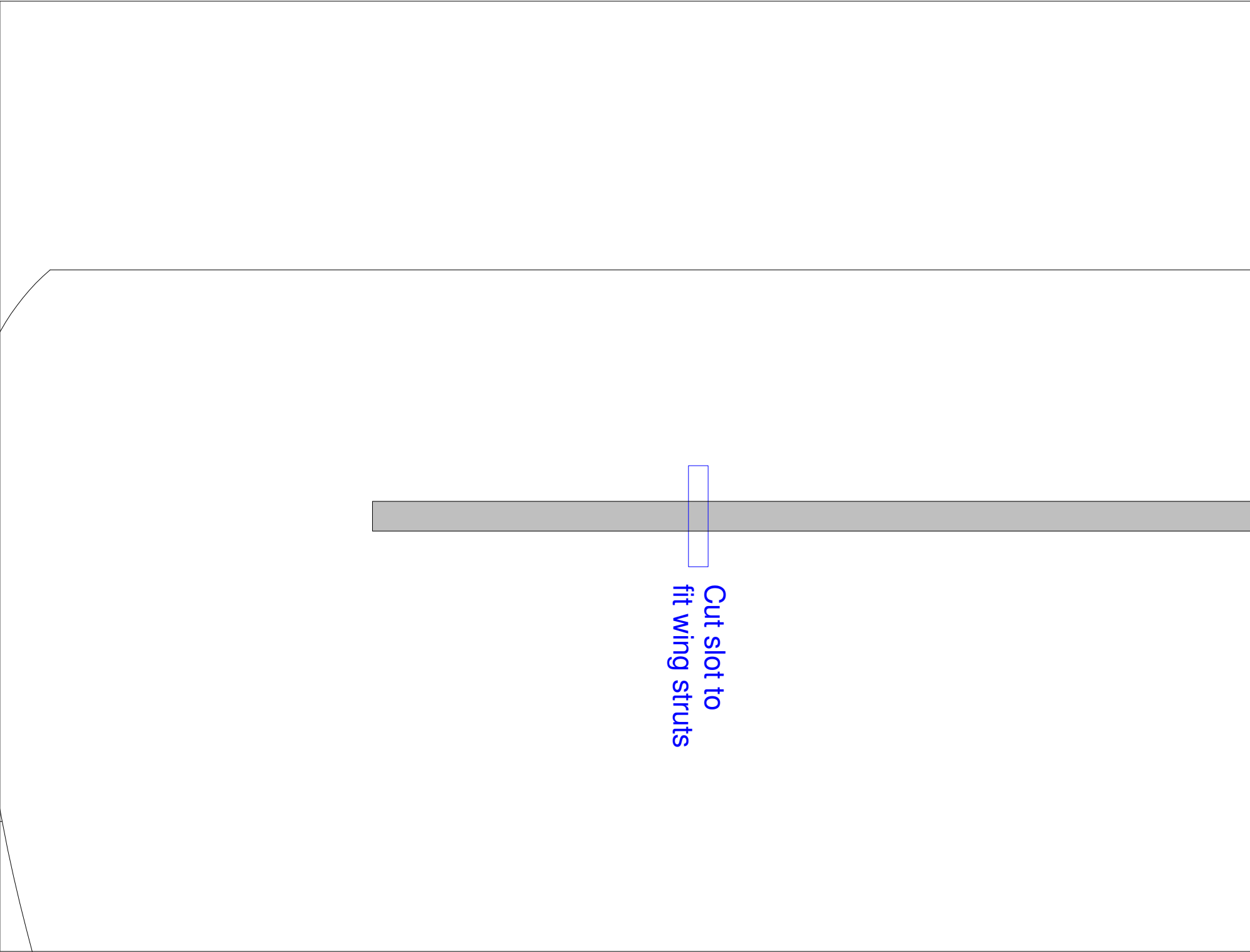

Cut slot to  
fit wing struts



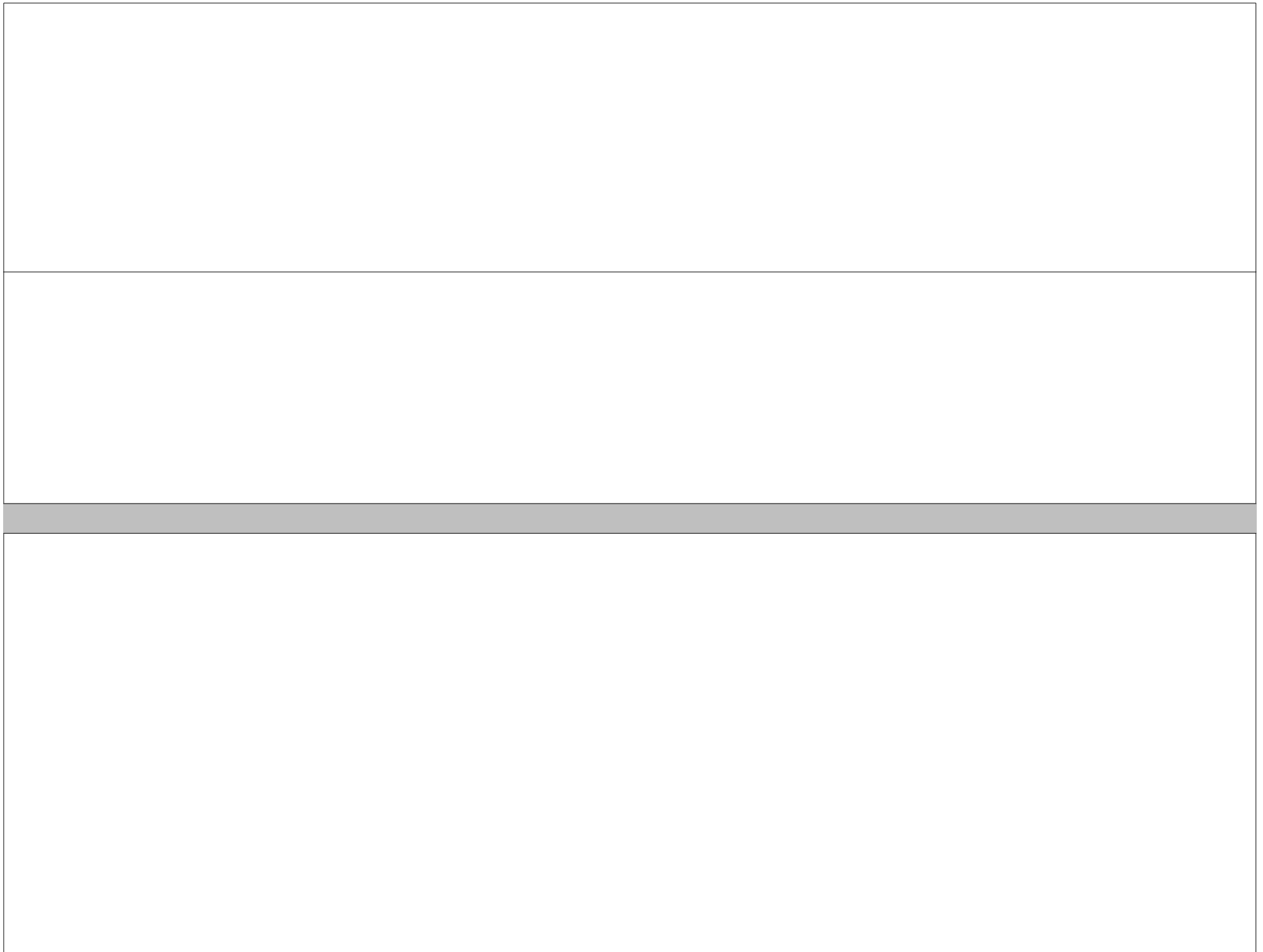

Upper wing  
(Make 1)

0.188" dia x 31.5"  
carbon tube spar



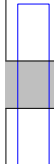
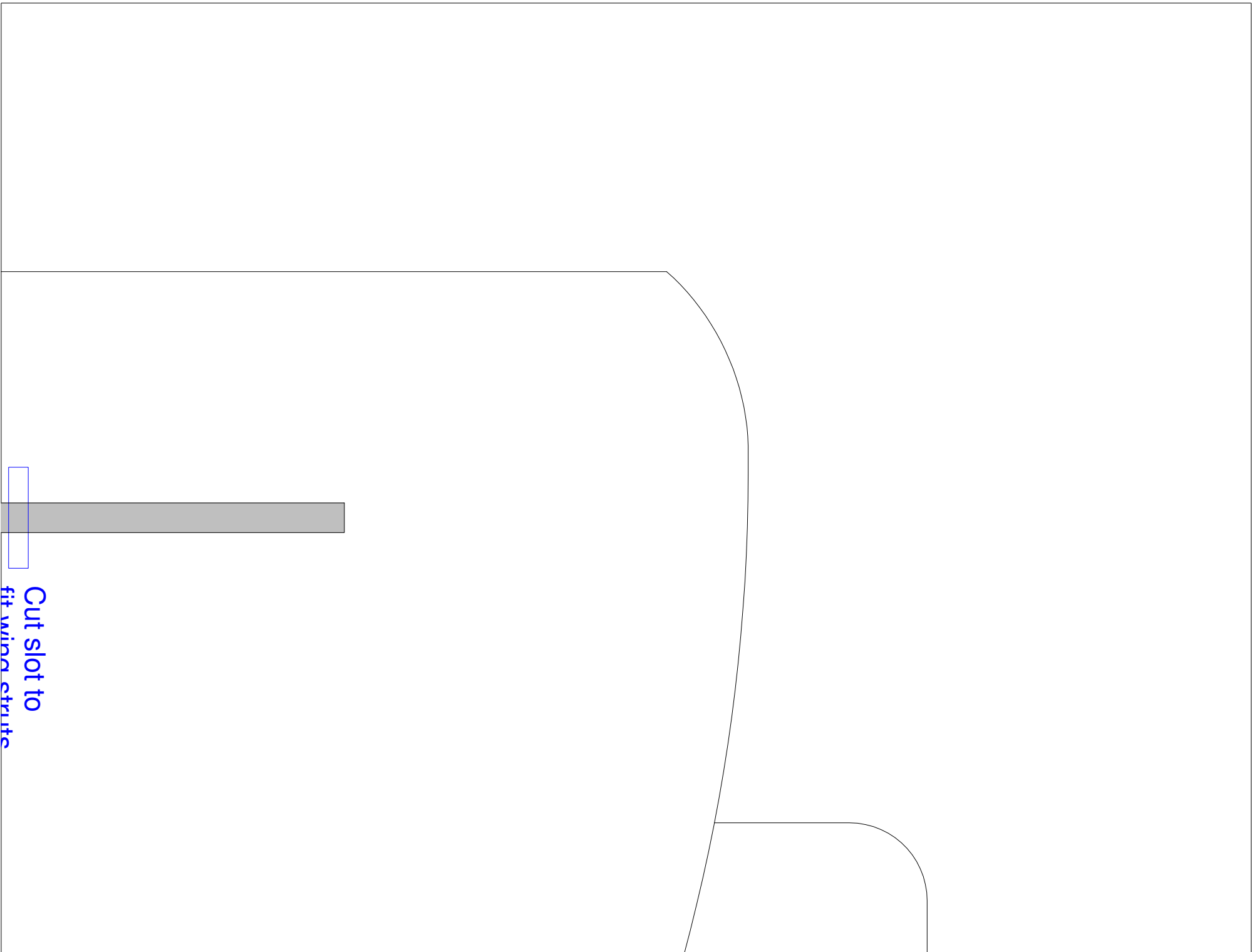

Cut slot to  
fit window struts