

FEATURES

- **High Current Transfer Ratio**
CNY17-1, 40 to 80%
CNY17-2, 63 to 125%
CNY17-3, 100 to 200%
CNY17-4, 160 to 320%
- **Breakdown Voltage, 5300 V**
- **Field-Effect Stable by TRIOS***
- **Long Term Stability**
- **Industry Standard Dual-in-Line Package**
- **Underwriters Lab File #E52744**
- **Option 1:**  **VDE #0884, add -X001 suffix**

DESCRIPTION

The CNY17 is an optically coupled pair consisting of a Gallium Arsenide infrared emitting diode optically coupled to a silicon NPN phototransistor.

Signal information, including a DC level, can be transmitted by the device while maintaining a high degree of electrical isolation between input and output.

The CNY17 can be used to replace relays and transformers in many digital interface applications, as well as analog applications such as CRT modulation.

Maximum Ratings (T_A=25°C)

Emitter	
Reverse Voltage	6 V
Forward Current	60 mA
Surge Current (t ≤ 10 μs)	2.5 A
Power Dissipation	100 mW

Detector	
Collector-Emitter Breakdown Voltage	70 V
Emitter-Base Breakdown Voltage	7 V
Collector Current	50 mA
Collector Current (t < 1 ms)	100 mA
Power Dissipation	150 mW

Package

Isolation Test Voltage (Between emitter & detector referred to climate DIN 40046, part 2, Nov. 74)	5300 VDC
Creepage Distance	≥ 27 mm
Clearance Distance	≥ 27 mm
Isolation Thickness between	
Emitter and Detector	≥ 0.4 mm
Comparative Tracking Index per DIN IEC 112/ VDE0303, part 1	175
Isolation Resistance	
V _{IO} =500 V, T _A =25°C	10 ¹² Ω
V _{IO} =500 V, T _A =100°C	10 ¹¹ Ω
Storage Temperature	-55°C to +150°C
Operating Temperature	-55°C to +100°C
Junction Temperature	100°C
Soldering Temperature (max. 10 s, dip soldering: distance to seating plane ≥ 1.5 mm)	260°C

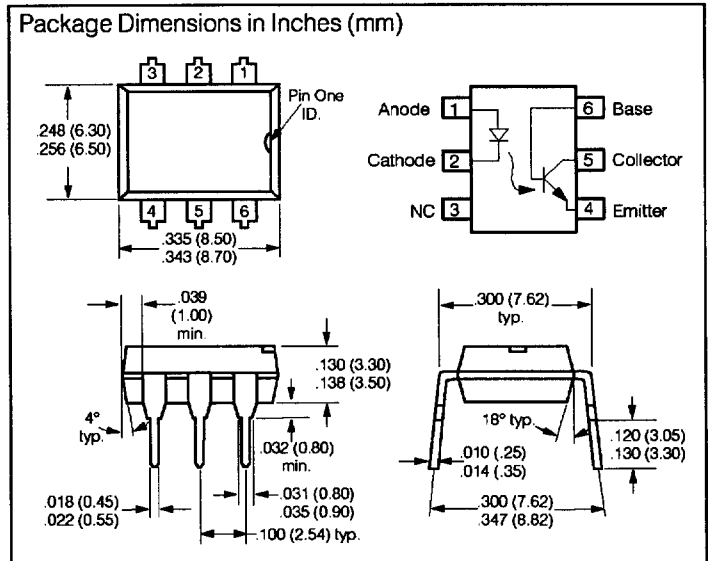

Characteristics (T_A=25°C)

	Symbol	Unit	Condition
Emitter			
Forward Voltage	V _F	1.25 (≤1.65) V	I _F = 60 mA
Breakdown Voltage	V _{BR}	≥ 6 V	I _R = 10 μA
Reverse Current	I _R	0.01 (≤10) μA	V _R = 6 V
Capacitance		25 pF	V _R = 0 V, f = 1 MHz
Thermal Resistance	R _{thjamb}	750 K/W	
Detector			
Capacitance	C _{CE}	5.2 pF	V _{CE} = 5 V, f = 1 MHz
	C _{CB}	6.5 pF	V _{CB} = 5 V, f = 1 MHz
	C _{EB}	7.5 pF	V _{EB} = 5 V, f = 1 MHz
Thermal Resistance	R _{thjamb}	500 K/W	
Package			
Collector-Emitter			I _F = 10 mA,
Saturation Voltage	V _{CEsat}	0.25 (≤0.4) V	I _C = 2.5 mA
Coupling Capacitance	C _C	0.6 pF	

Current Transfer Ratio and Collector-Emitter Leakage Current by dash number ($T_A=25^\circ\text{C}$)

	-1	-2	-3	-4	Unit
I_C/I_F at $V_{CE}=5\text{ V}$ ($I_F=10\text{ mA}$)	40-80	63-125	100-200	160-320	%
I_C/I_F at $V_{CE}=5\text{ V}$ ($I_F=1\text{ mA}$)	30 (>13)	45 (>22)	70 (>34)	90 (>56)	%
Collector-Emitter Leakage Current ($V_{CE}=10\text{ V}$) (I_{CEO})	2 (≤ 50)	2 (≤ 50)	5 (≤ 100)	5 (≤ 100)	nA

Linear Operation (without saturation)

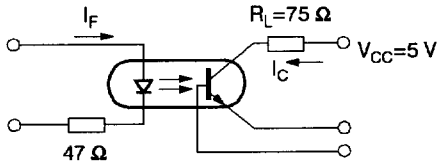

$I_F=10\text{ mA}$, $V_{CC}=5\text{ V}$, $T_A=25^\circ\text{C}$

Load Resistance	R_L	75	Ω
Turn-On Time	t_{ON}	3.0	μs
Rise Time	t_R	2.0	μs
Turn-Off Time	t_{OFF}	2.3	μs
Fall Time	t_f	2.0	μs
Cut-Off Frequency	f_{CO}	250	kHz

Switching Operation (with saturation)

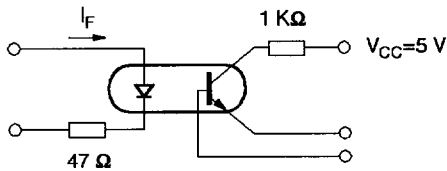

	-1 ($I_F=20\text{ mA}$)	-2 and -3 ($I_F=10\text{ mA}$)	-4 ($I_F=5\text{ mA}$)	
Turn-On Time t_{ON}	3.0	4.2	6.0	μs
Rise Time t_R	2.0	3.0	4.6	μs
Turn-Off Time t_{OFF}	18	23	25	μs
Fall Time t_f	11	14	15	μs

Current transfer ratio versus diode current ($T_A=-25^\circ\text{C}$, $V_{CE}=5\text{ V}$)

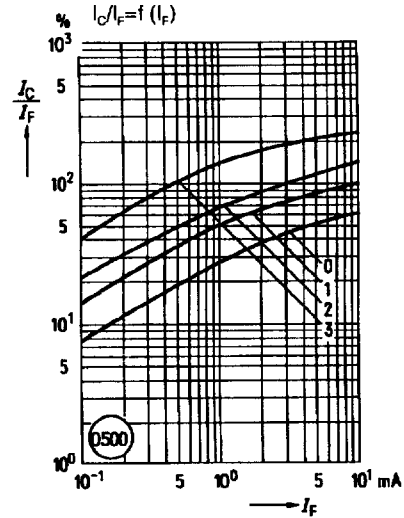

Current transfer ratio versus diode current ($T_A=0^\circ\text{C}$, $V_{CE}=5\text{ V}$)

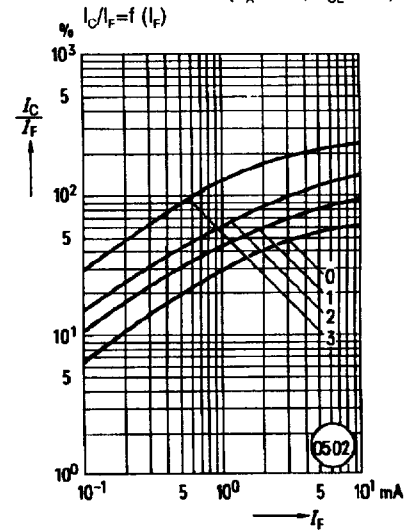

Current transfer ratio versus diode current ($T_A=25^\circ\text{C}$, $V_{CE}=5\text{ V}$)

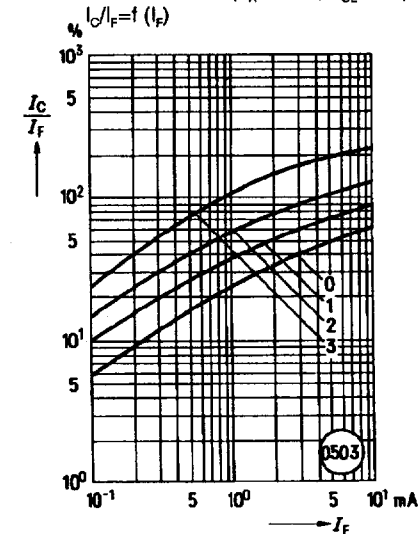

Current transfer ratio versus diode current ($T_A=50^\circ\text{C}$) $V_{CE}=5\text{ V}$

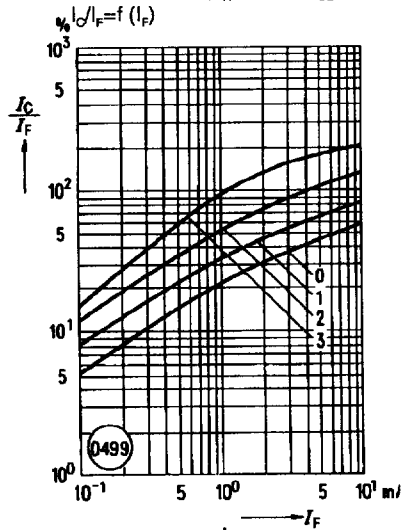

Transistor characteristics ($B=550$)
CNY17-3, -4 $I_C=f(V_{CE})$ ($T_A=25^\circ\text{C}$, $I_F=0$)

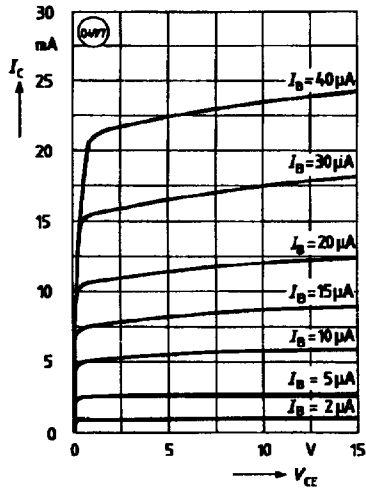

Collector emitter off-state current
 $I_{CEO}=f(V, T)$ ($T_A=25^\circ\text{C}$, $I_F=0$)

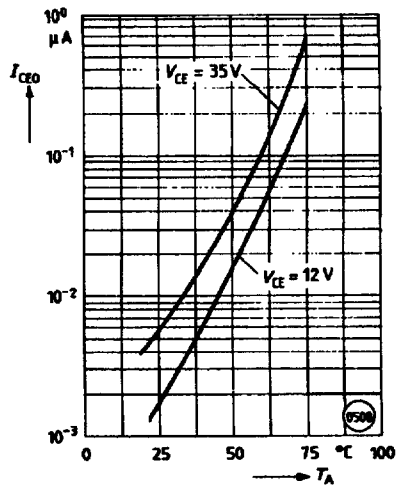

Current transfer ratio versus diode current ($T_A=75^\circ\text{C}$) $V_{CE}=5\text{ V}$

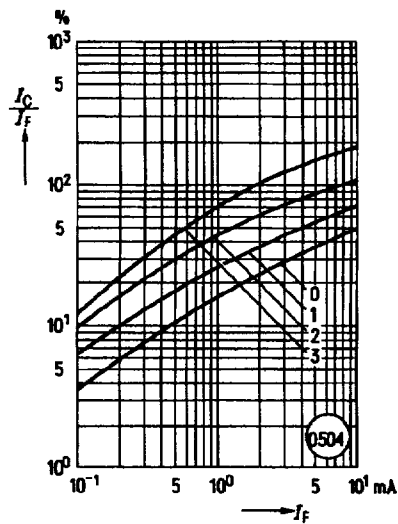

Output characteristics
CNY17-3, -4 ($T_A=25^\circ\text{C}$) $I_C=f(V_{CE})$

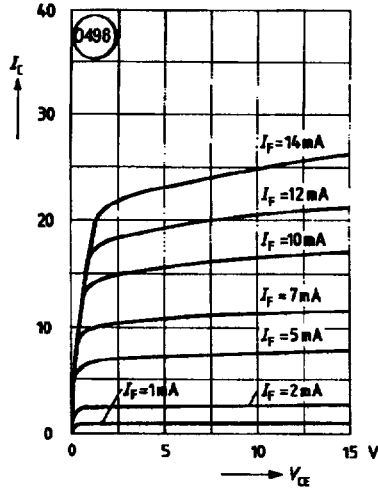

Saturation voltage versus collector current and modulation depth
CNY17-1 $V_{CEsat}=f(I_C)$ ($T_A=25^\circ\text{C}$)

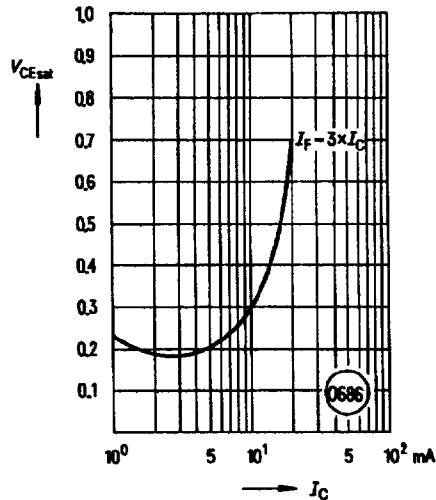

Current transfer ratio versus temperature ($I_F=10\text{ mA}$, $V_{CE}=5\text{ V}$)

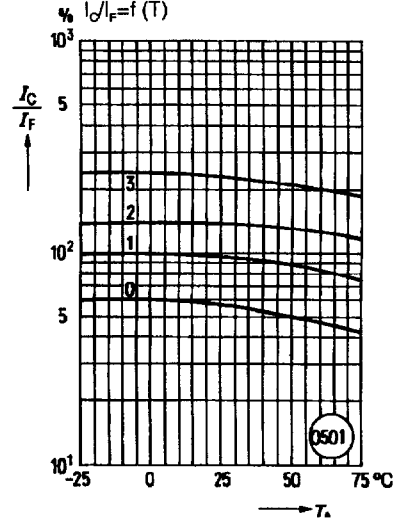

Forward voltage $V_F=f(I_F)$

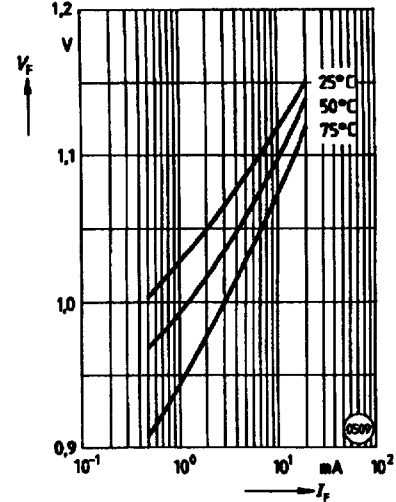

Saturation voltage versus collector current and modulation depth
CNY17-2 $V_{CEsat}=f(I_C)$ ($T_A=25^\circ\text{C}$)

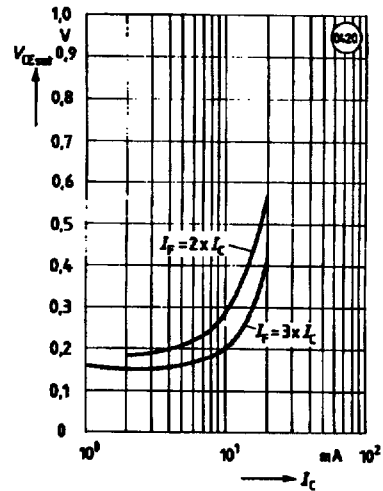

Saturation voltage versus collector current and modulation depth
CNY17-3 $V_{CEsat}=f(I_C)$ ($T_A=25^\circ\text{C}$)

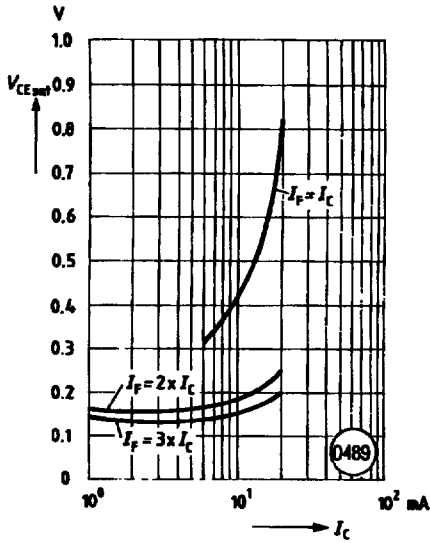

Saturation voltage versus collector current and modulation depth
CNY17-4 $V_{CEsat}=f(I_C)$ ($T_A=25^\circ\text{C}$)

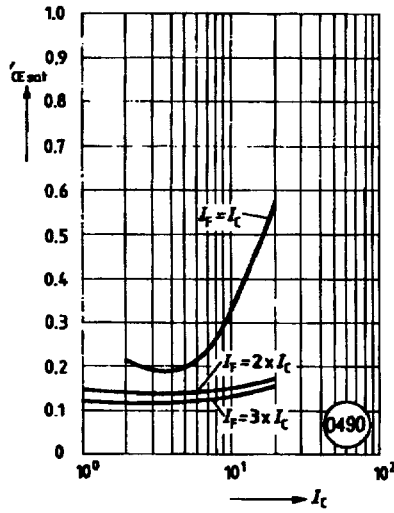

Permissible pulse load
 $D=\text{parameter}$, $T_A=25^\circ\text{C}$, $I_f=f(t_p)$

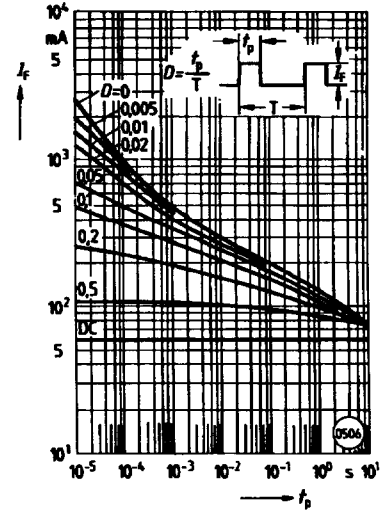

Permissible power dissipation transistor and diode
 $P_{tot}=f(T_A)$

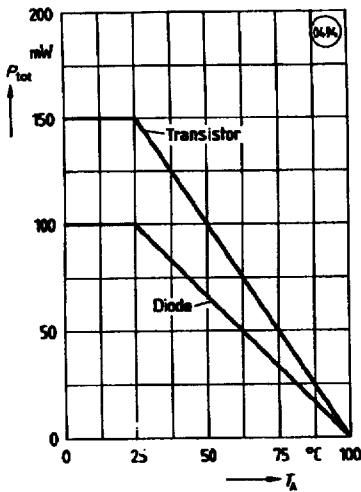

Permissible forward current
 $P_{tot}=f(T_A)$

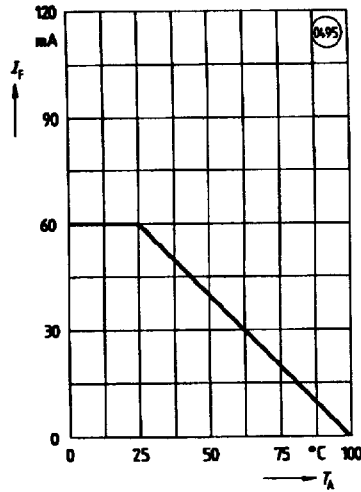

Transistor capacitance
 $C=f(V_C)$ ($T_A=25^\circ\text{C}$, $f=1\text{ MHz}$)

