

3mm

fold

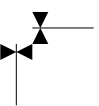

Grid (1 , 2)

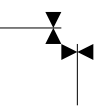
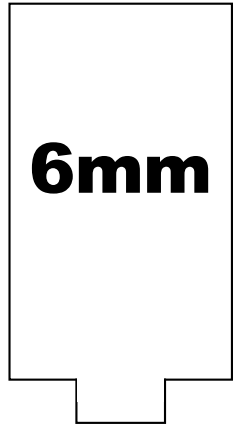
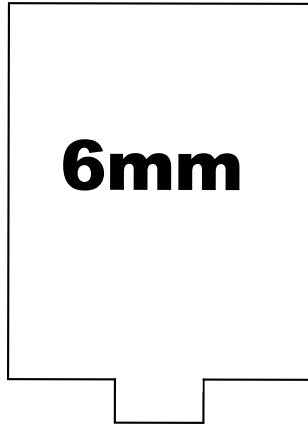
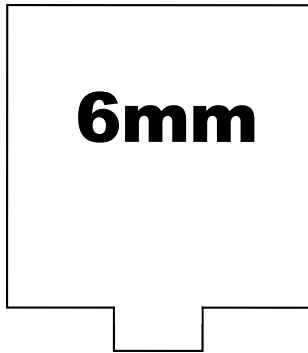
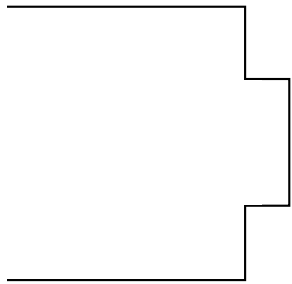
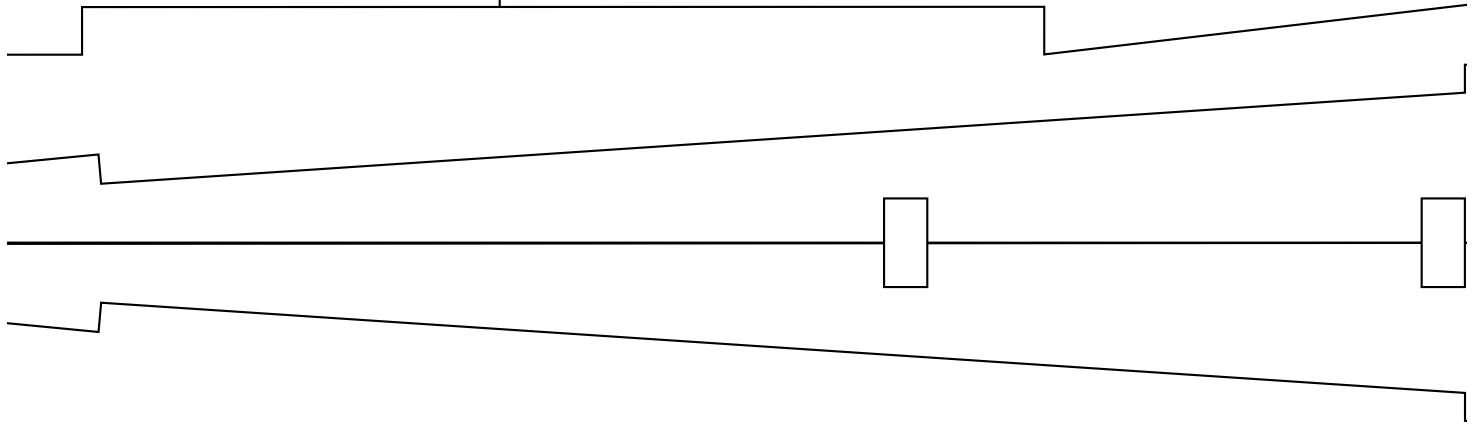
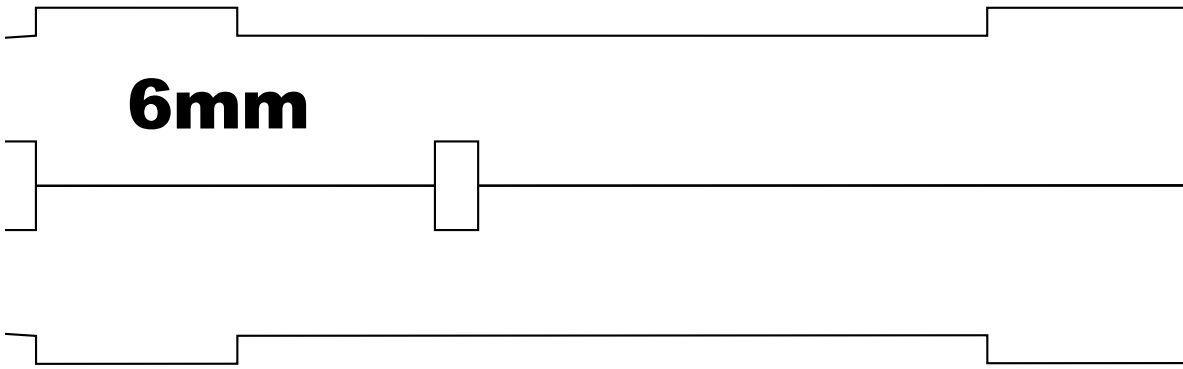
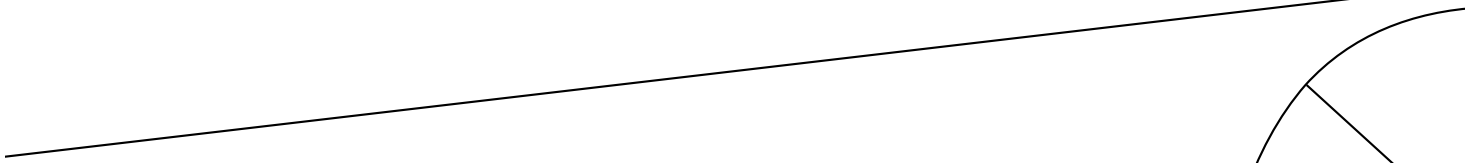
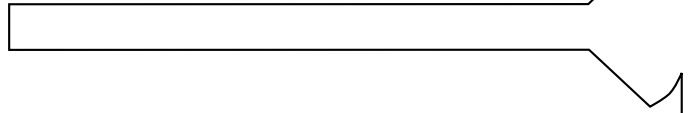
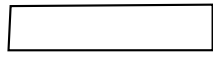
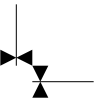
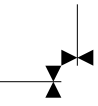

6mm

6m

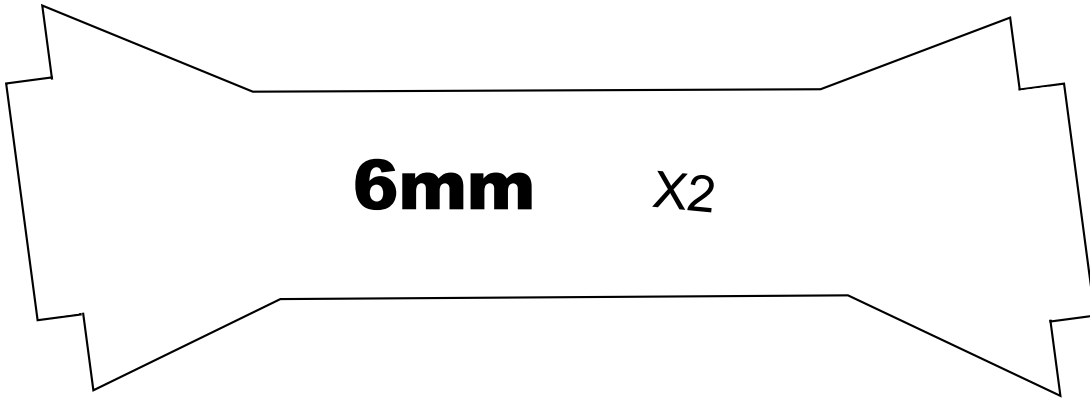

6mm X2

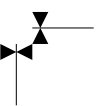
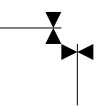

hinge



mm

hinge line

Grid (1 , 4)

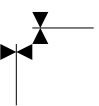
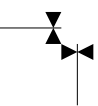
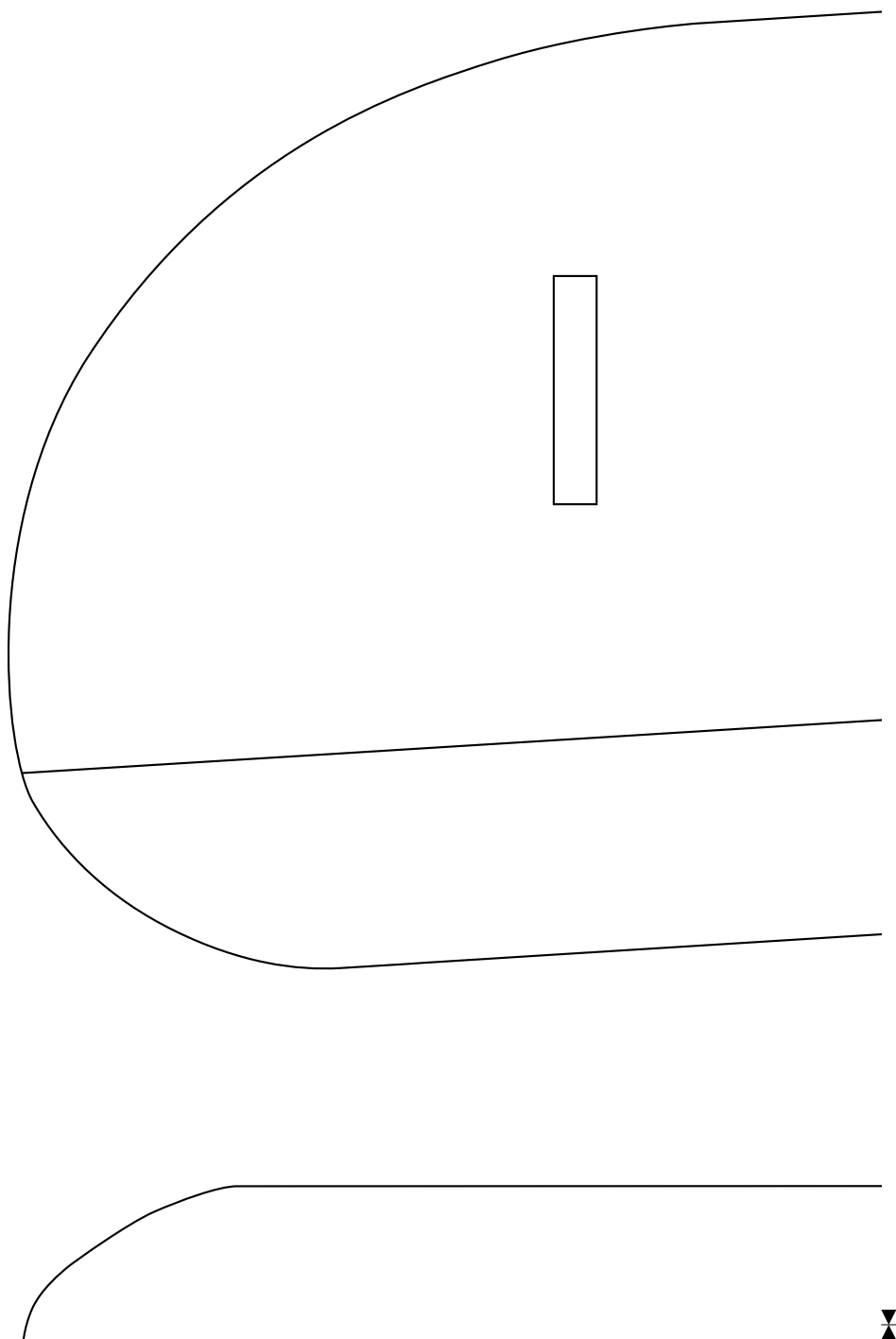
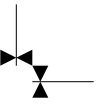
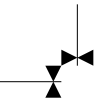

Grid (2 , 1)

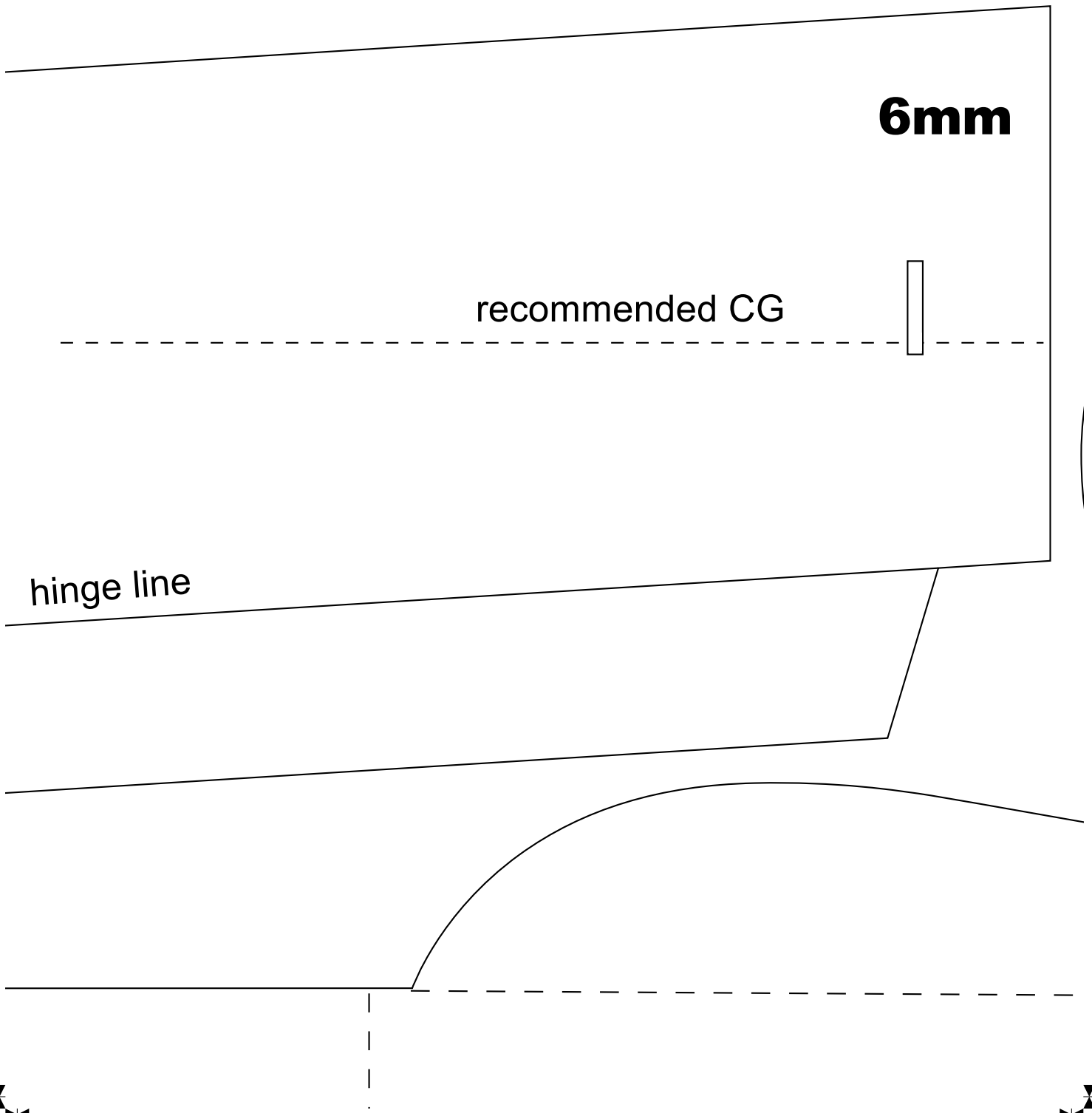
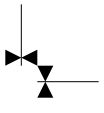
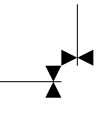

6mm

recommended CG

hinge line

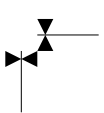
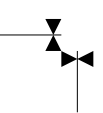

Grid (2 , 2)

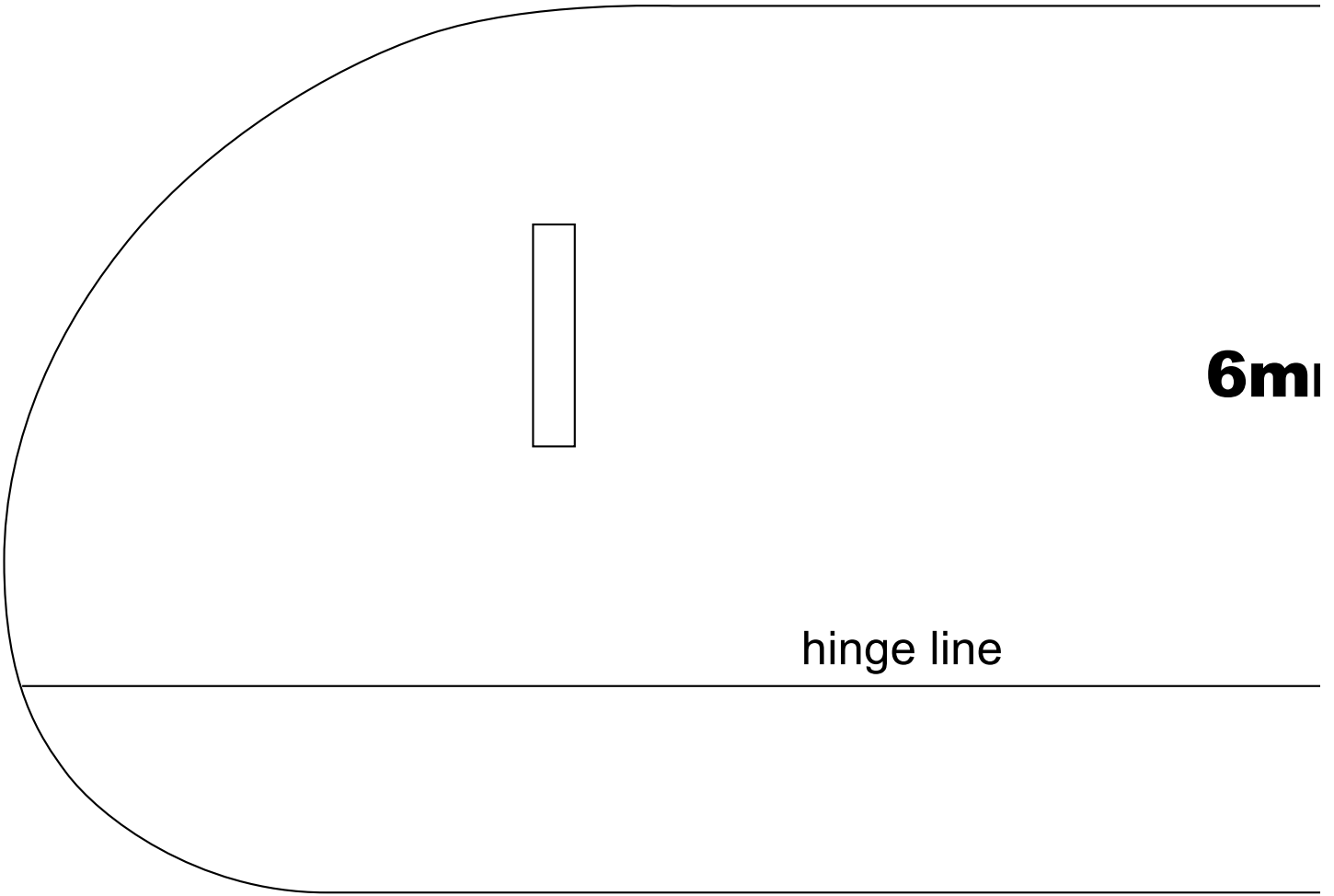
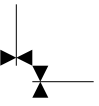
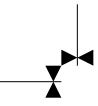

6m

hinge line

fold

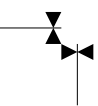
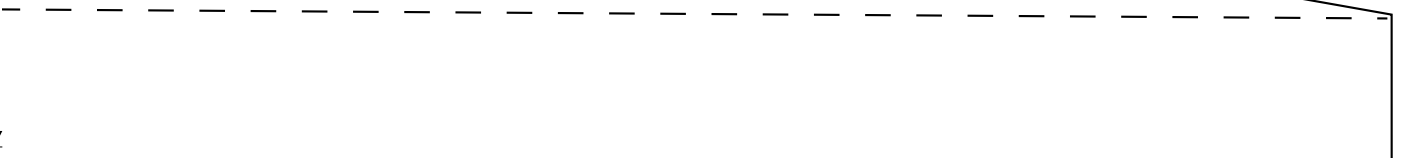

Grid (2 , 3)

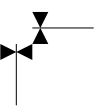

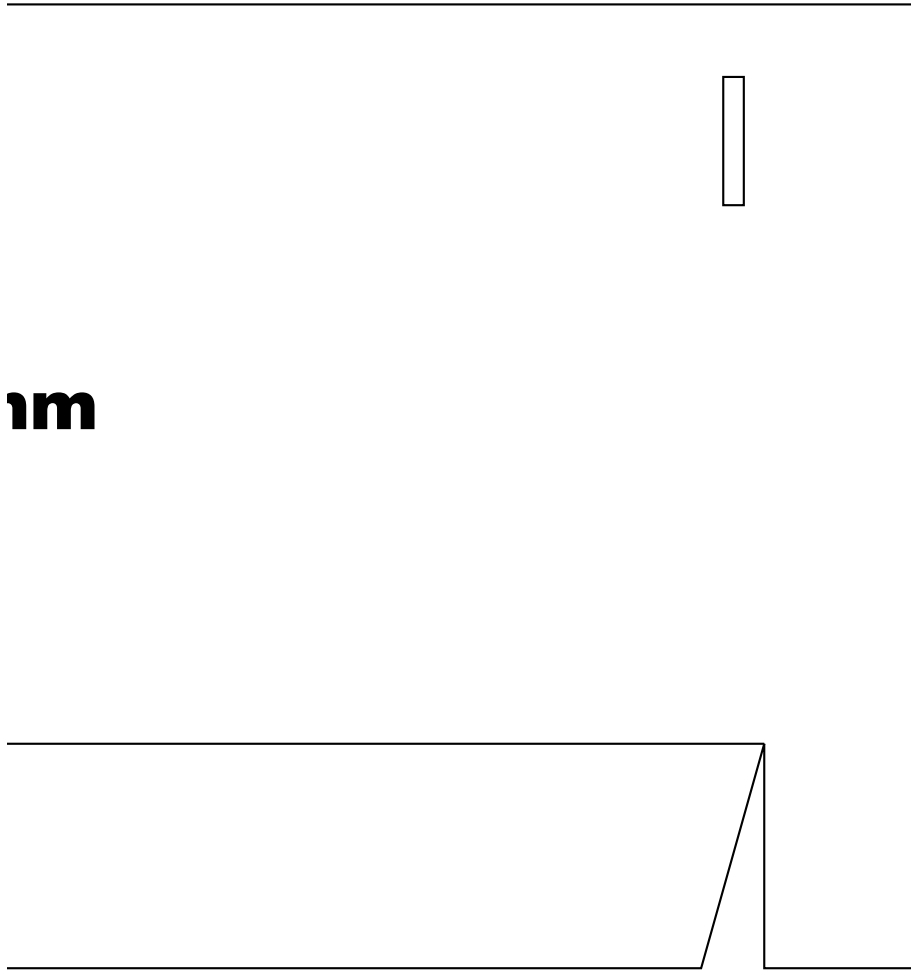
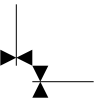
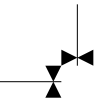

1m

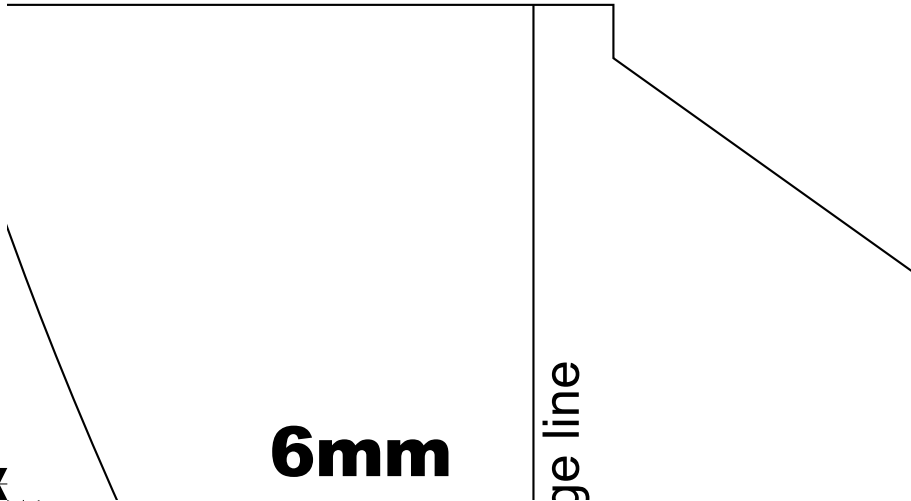

6mm

ge line

Grid (2 , 4)

