

row1, col1

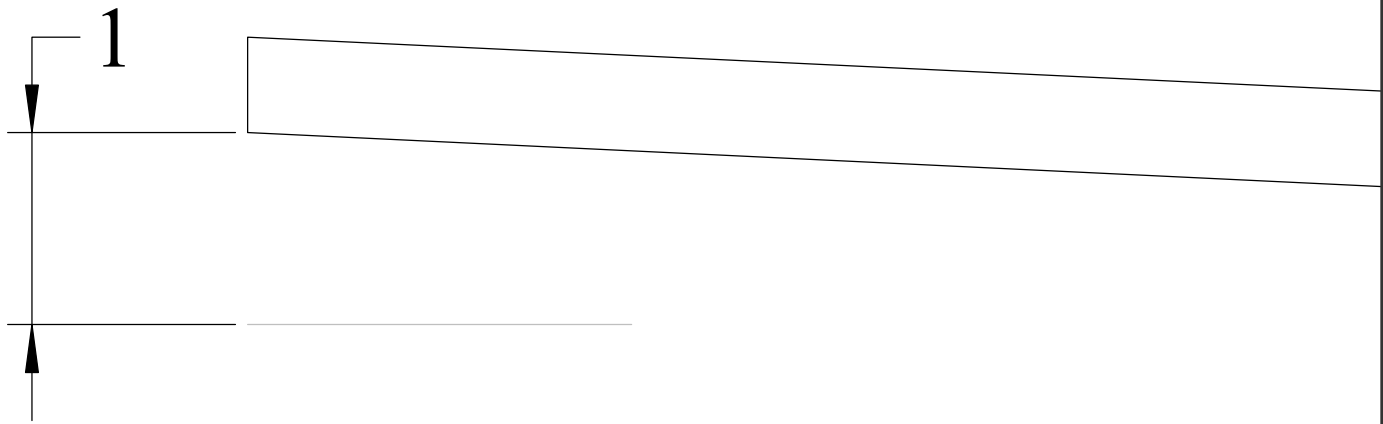

row1, col2

row1, col3

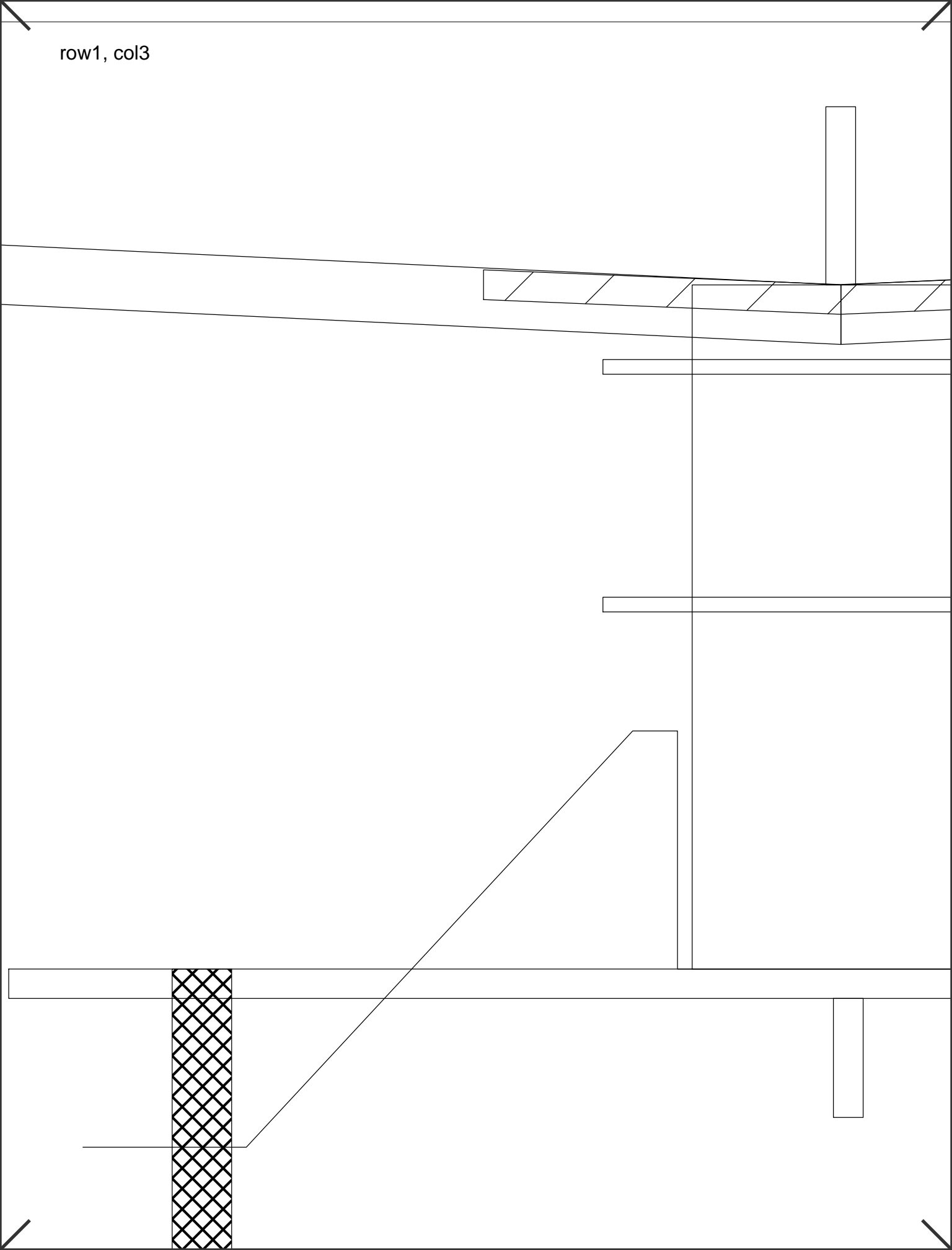

row1, col4

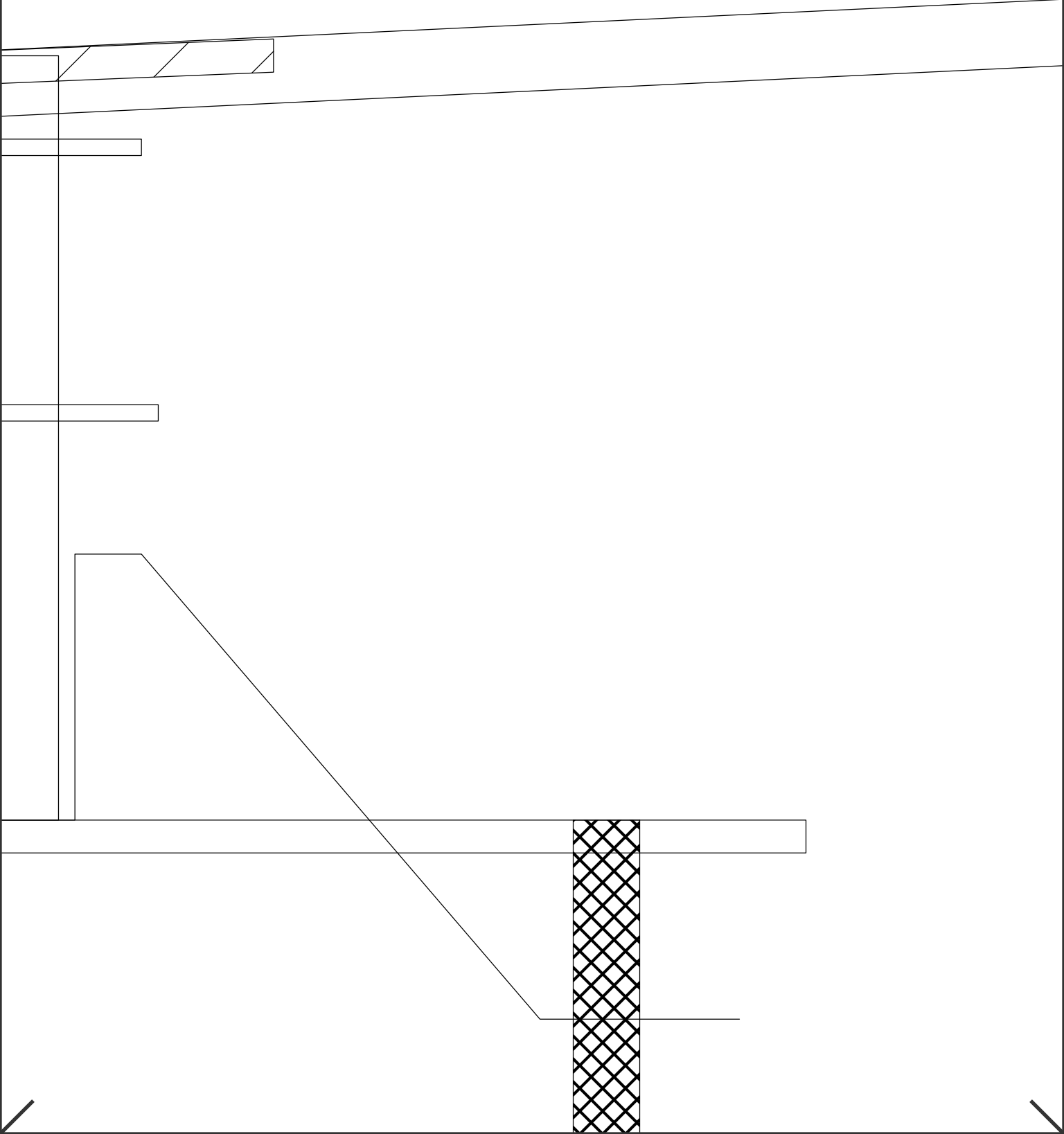

row1, col5

row1, col6

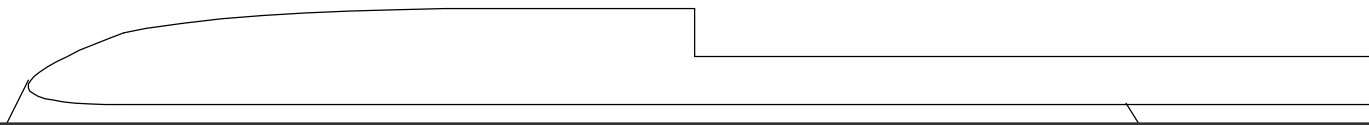

row1, col7

row1, col8

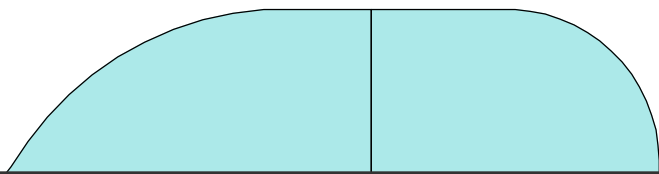

row1, col9

row2, col1

The "Tuffy"

by Tony65x55

This aircraft is an easy to build, super tough trainer, suitable for all training applications, from basic to advanced. It uses simple monobloc construction techniques and the time-proven KFm2 airfoil. It is designed to be easy to fly, yet expandable in scope to include ailerons and flaperons to meet all of your training needs

These plans are intended for personal use and commercial sale and usage are not permitted.

Wing S
Wing A
Aspect
RTF W
Wing L
Starting

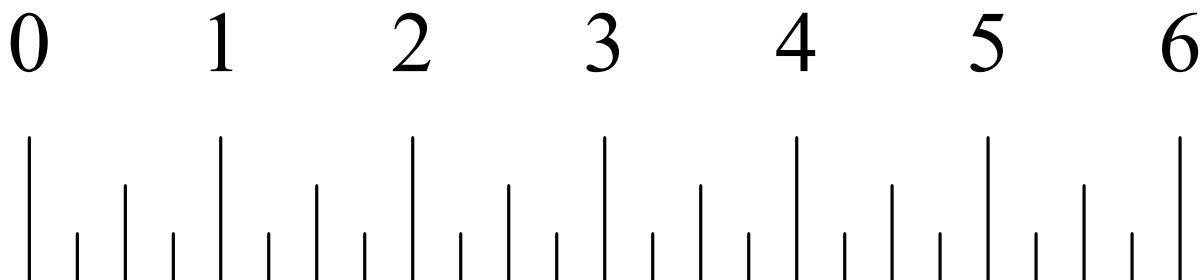

Scale in inches

row2, col3

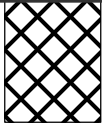

Span: 42"

Area: 311 sq/in

Ratio: 5.67

Weight: 15 oz

Loading: 7 oz/sq ft.

CG: 2.75" from LE at root.

row2, col4

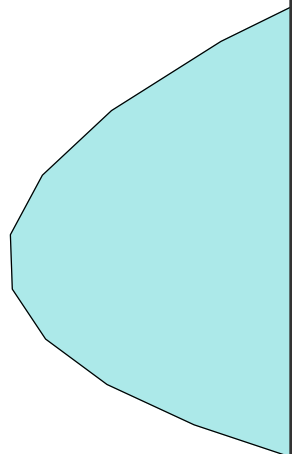
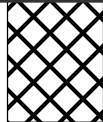

row2, col5

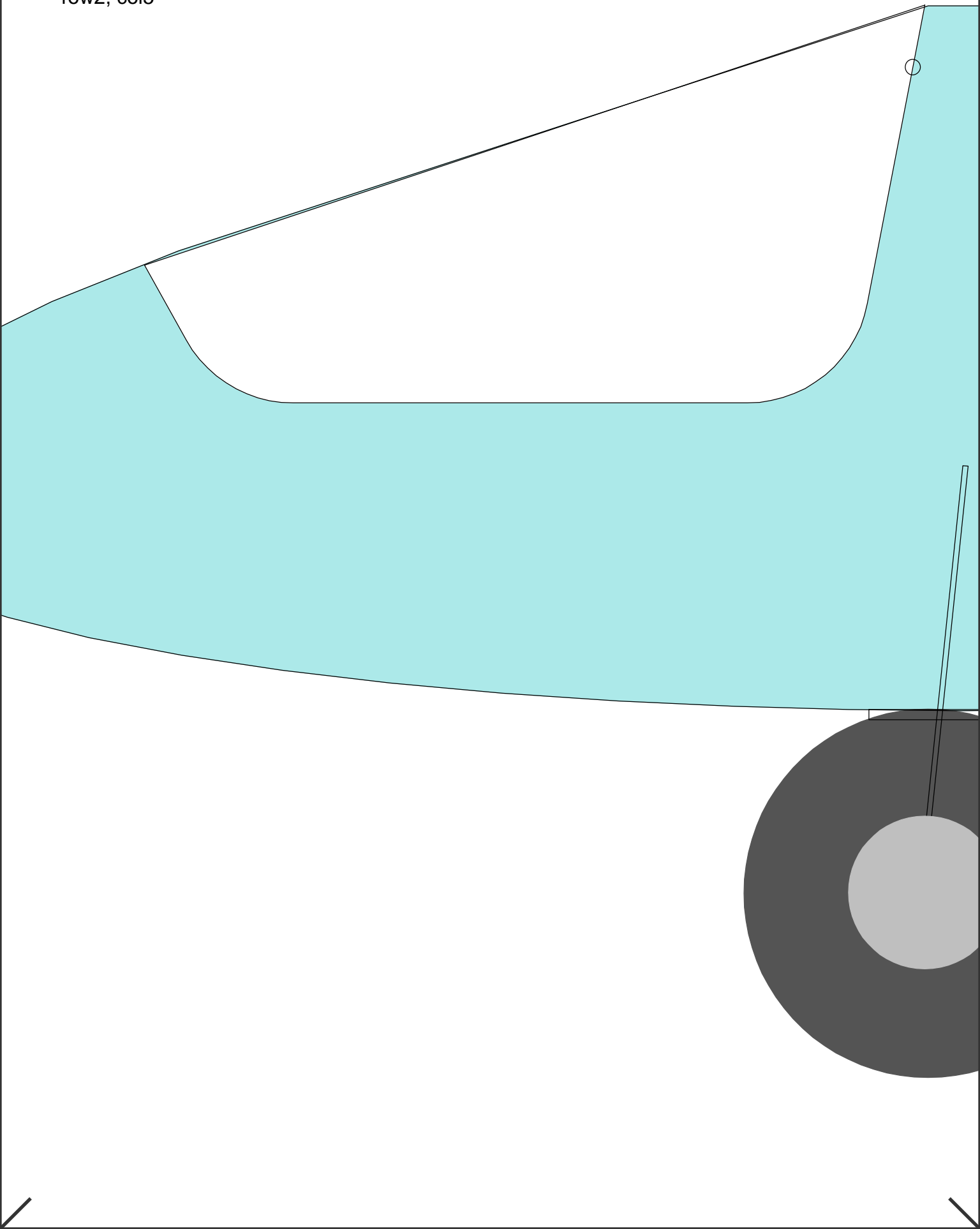

row2, col6

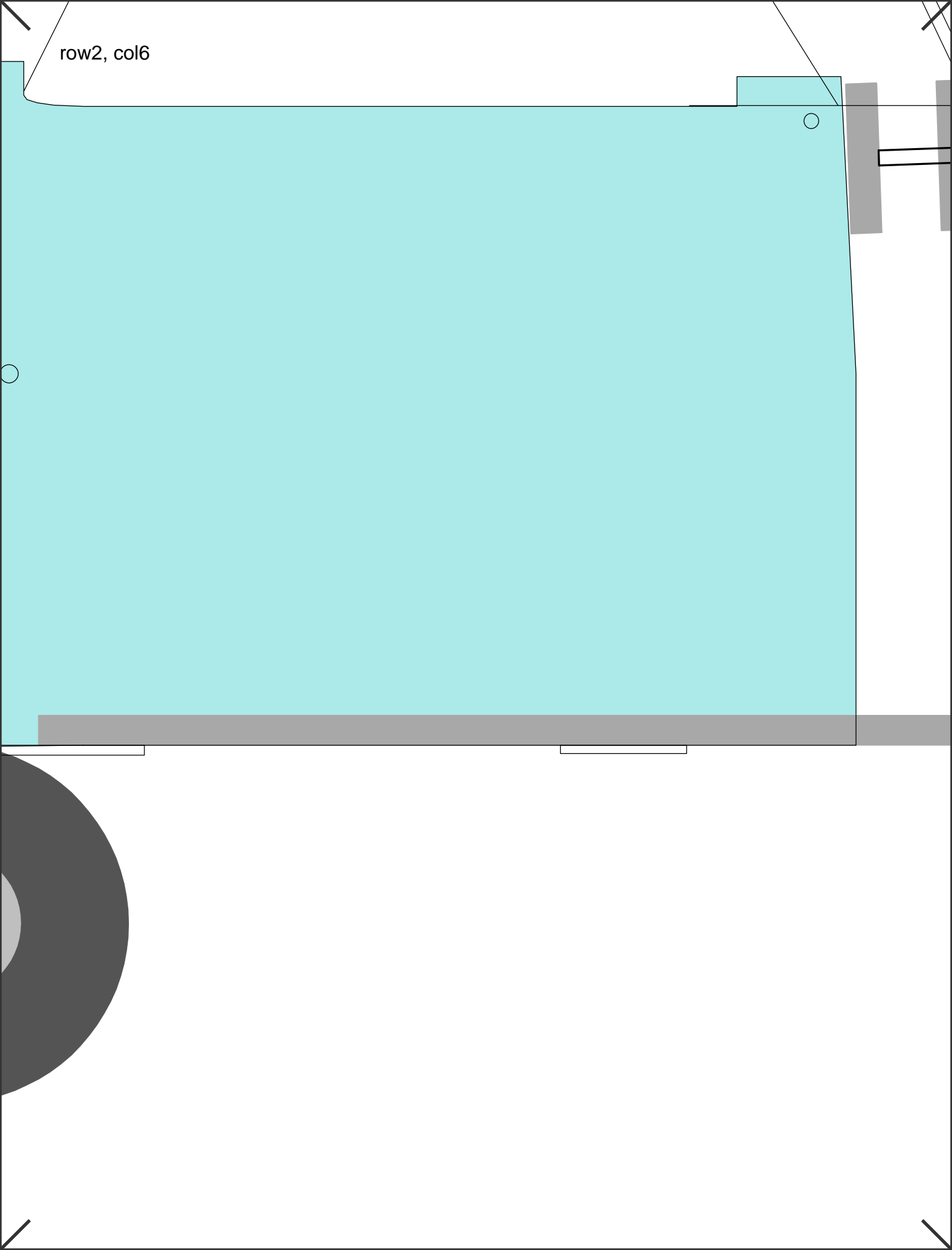

row2, col7

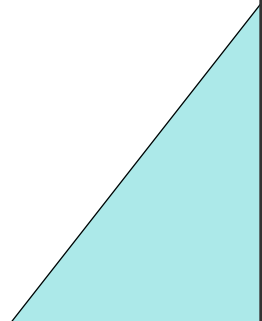
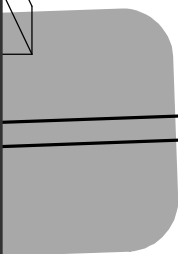

row2, col8

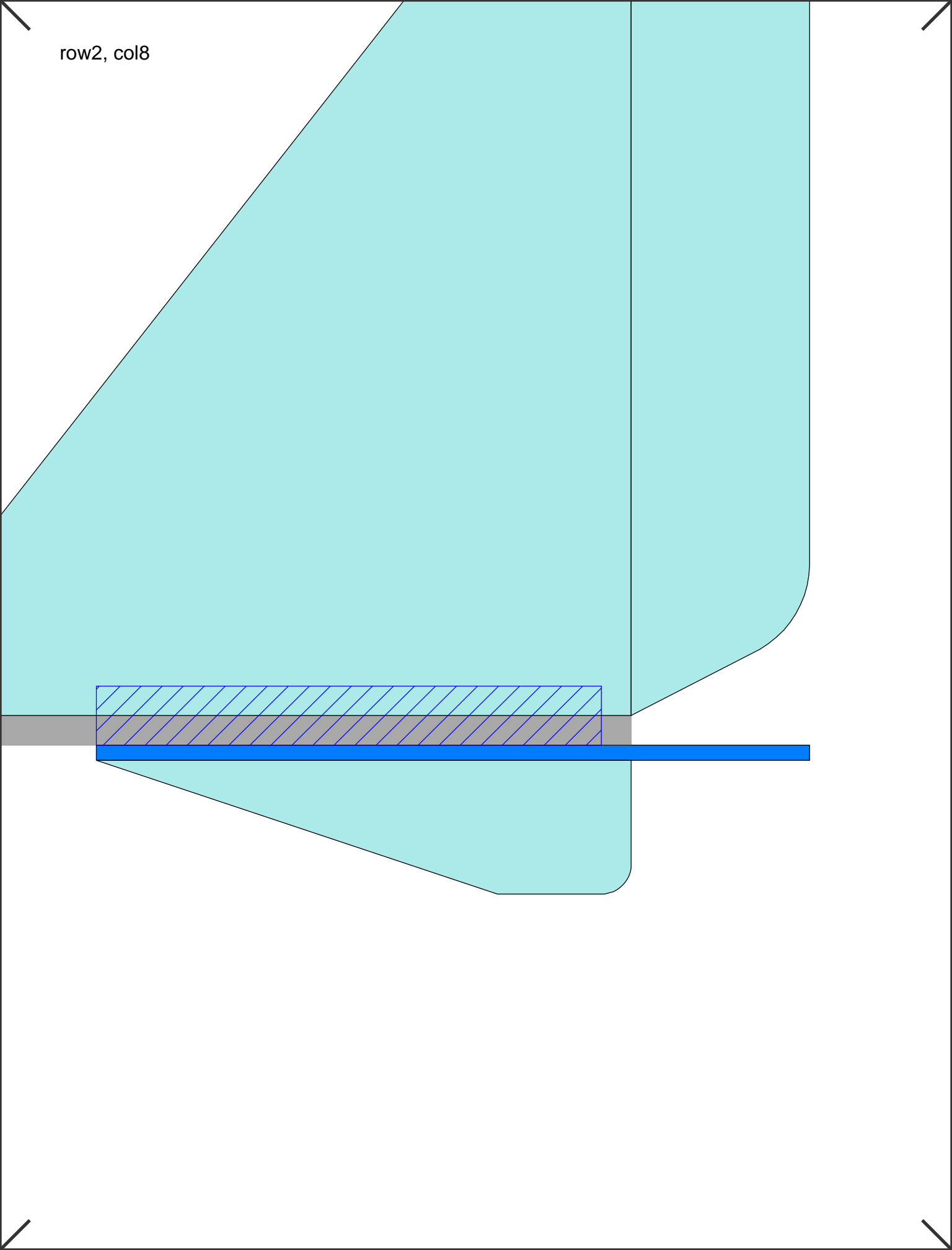

row2, col9

row3, col1

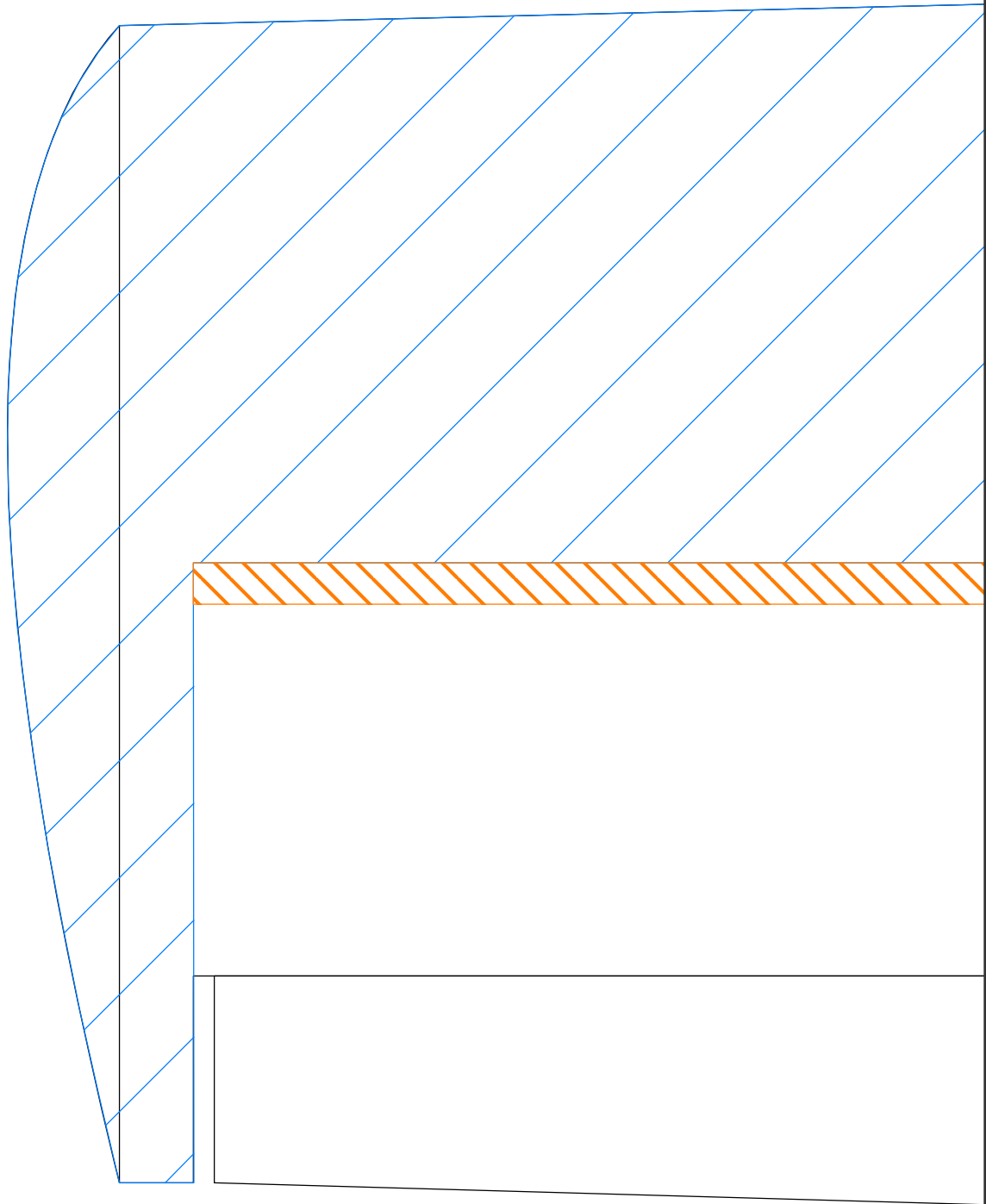

row3, col2

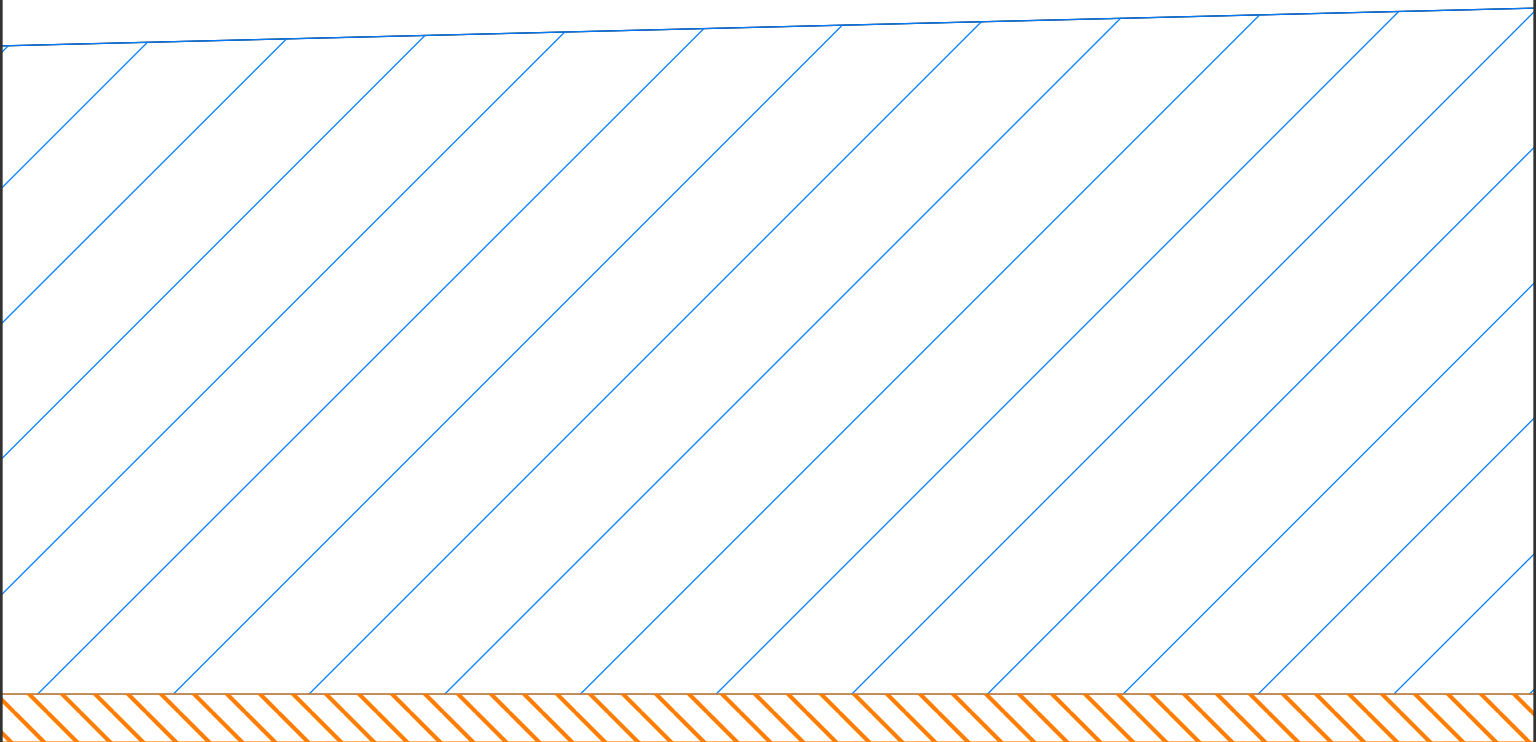

row3, col3

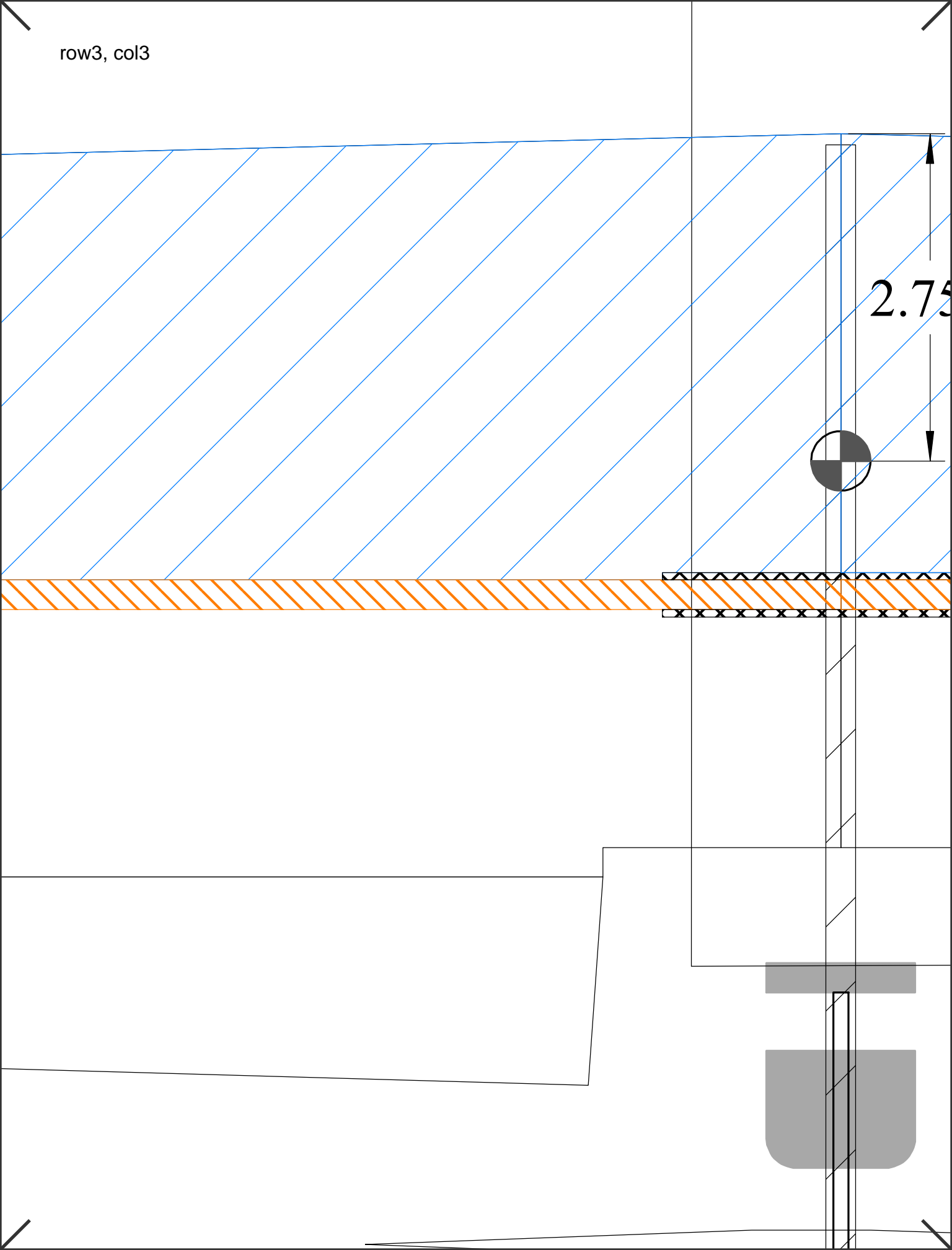

row3, col4

50

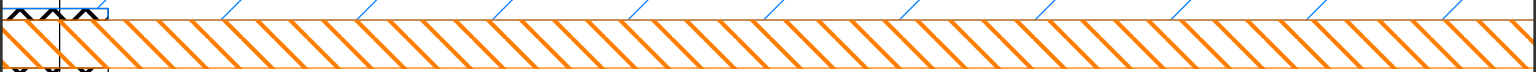

row3, col5

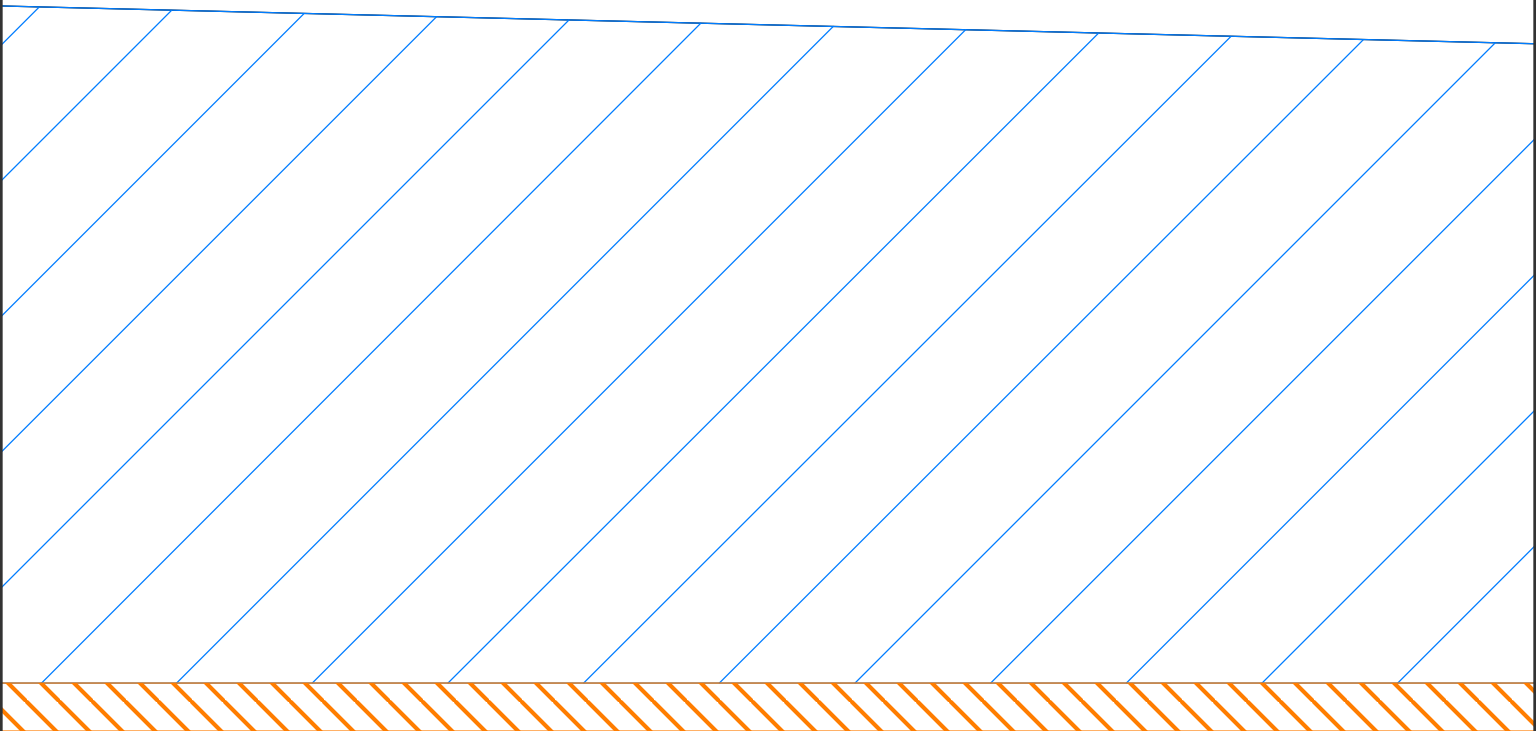

row3, col6

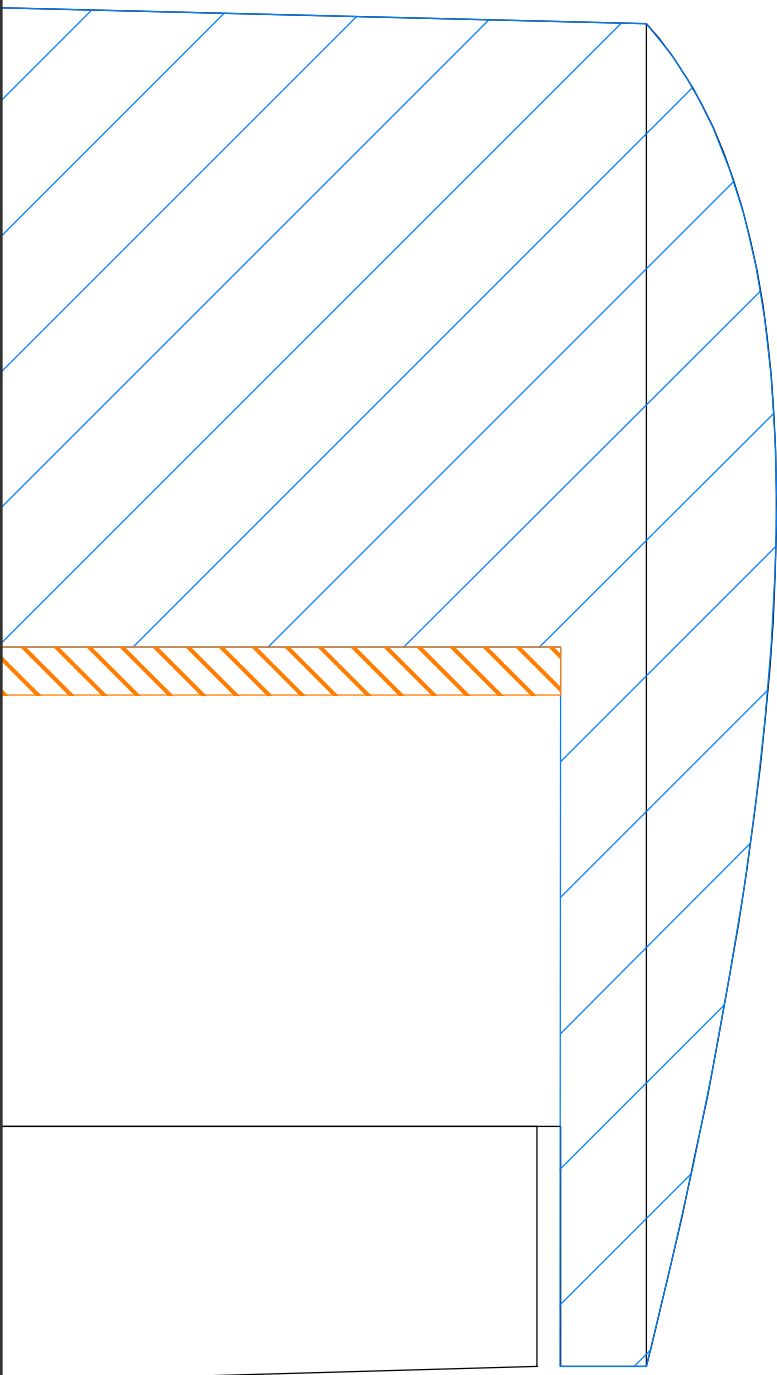

row3, col7

row3, col8

row3, col9

row4, col1

row4, col2

row4, col3

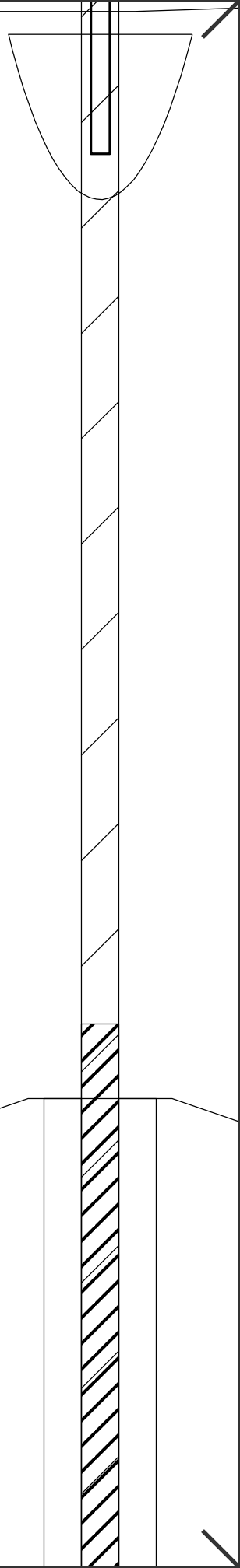

row4, col4

row4, col5

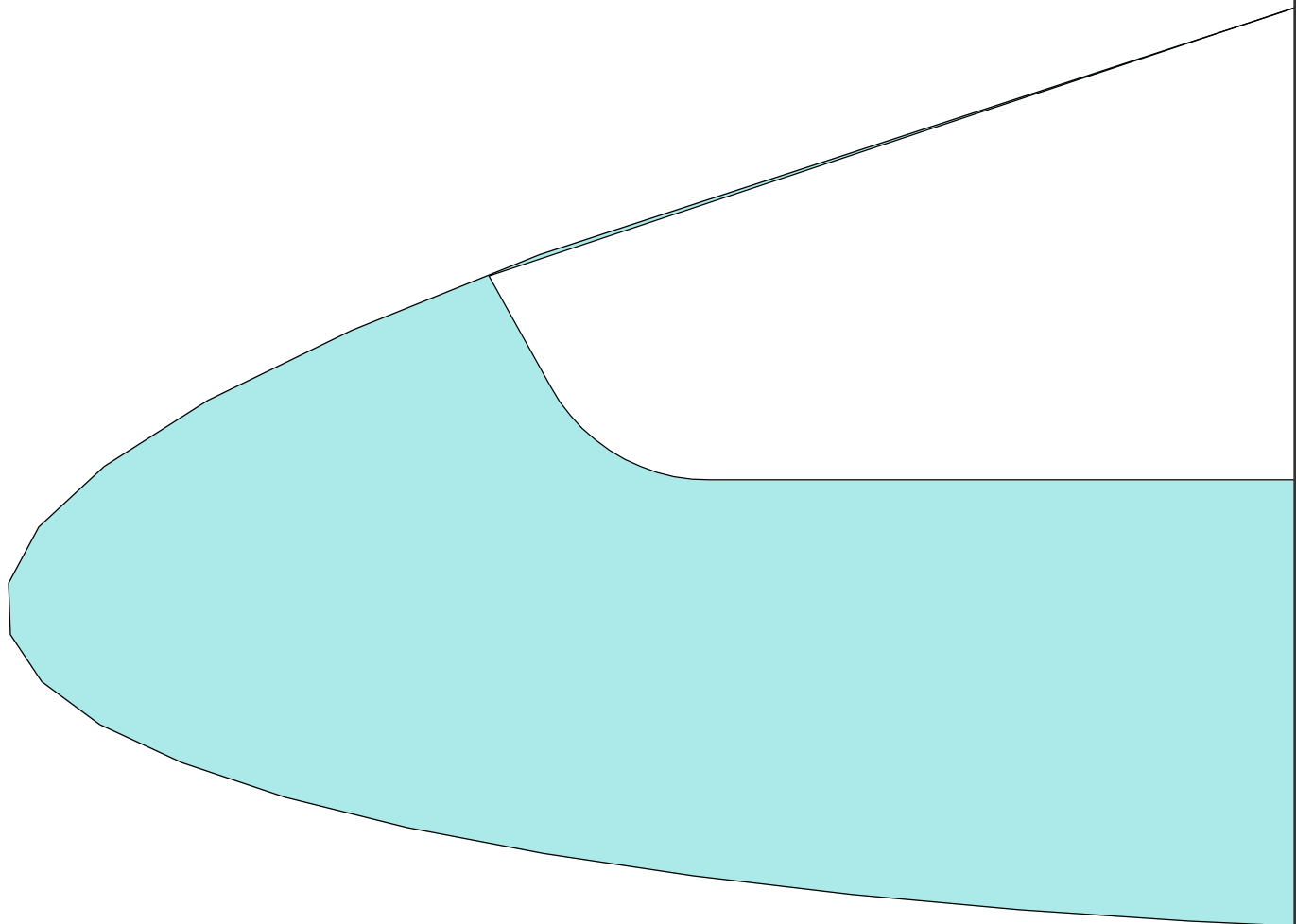

row4, col6

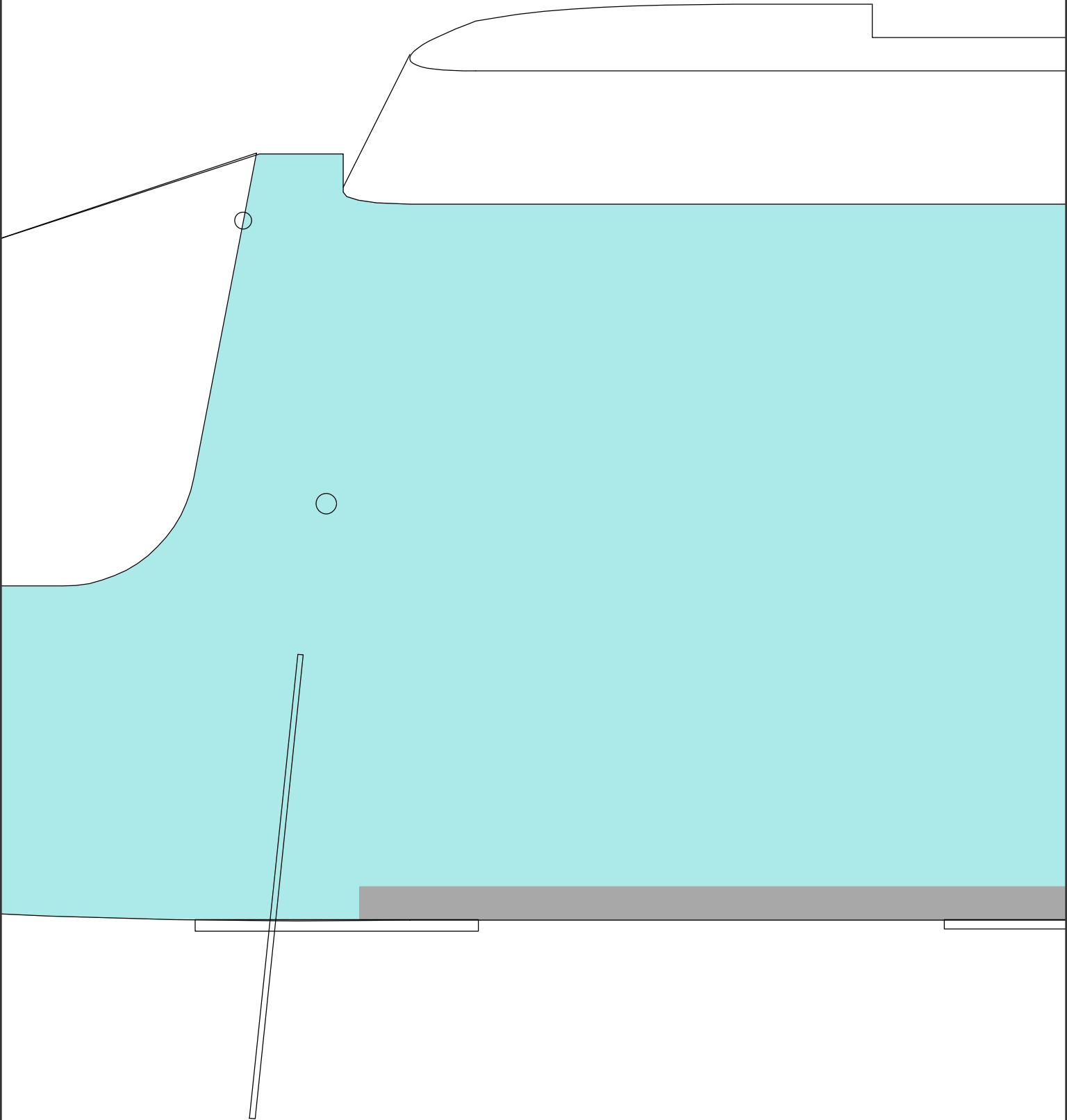

row4, col7

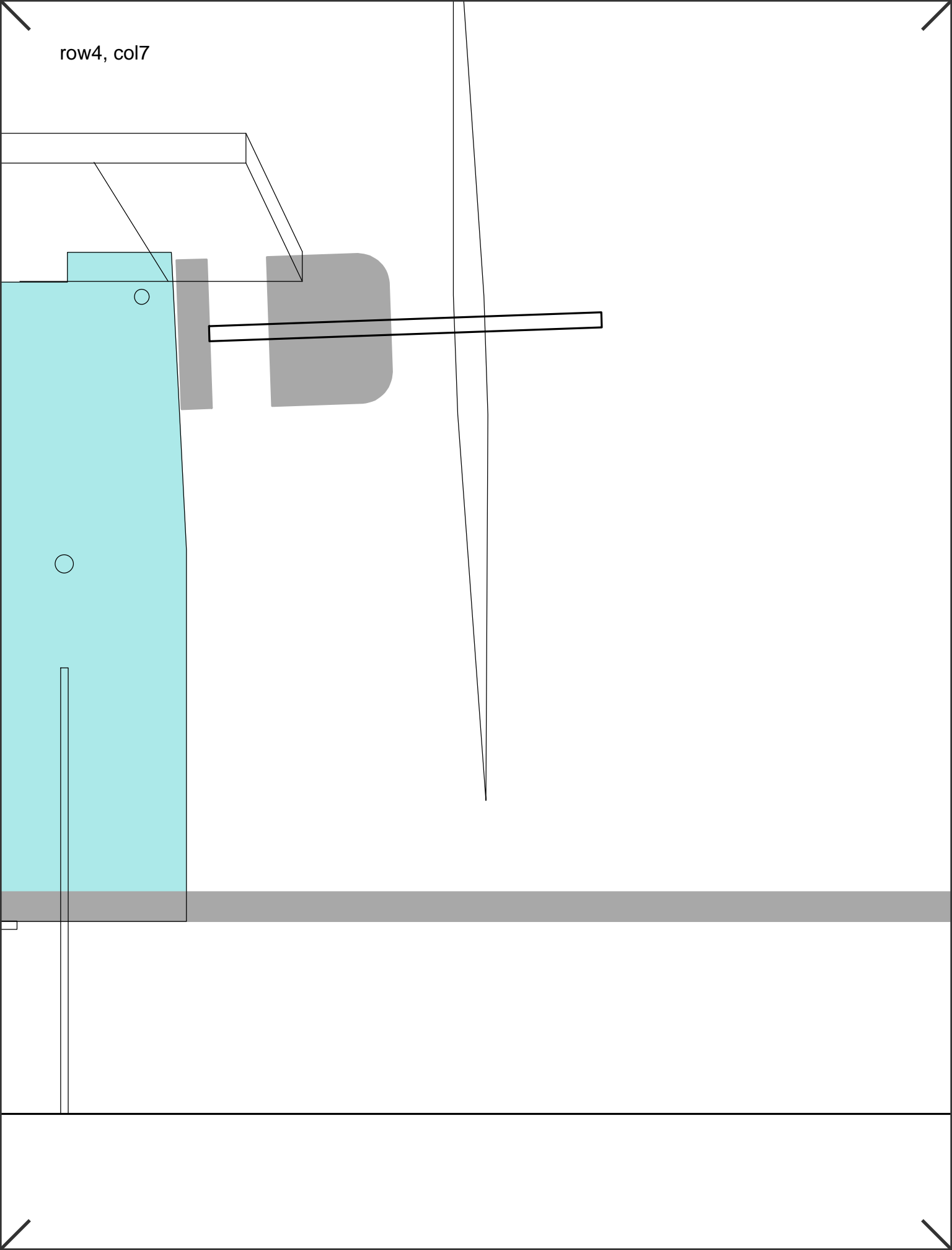

row4, col8

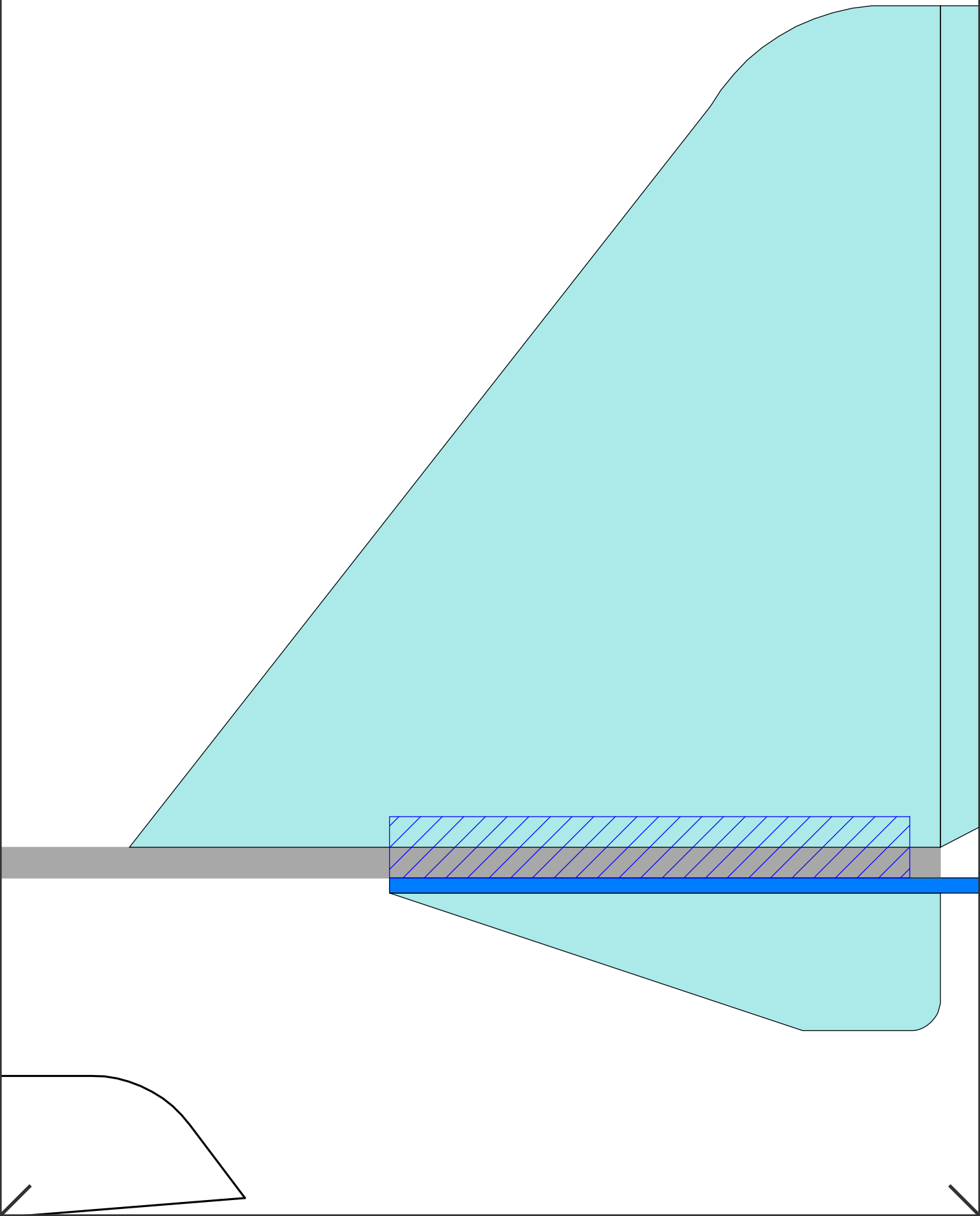

row4, col9

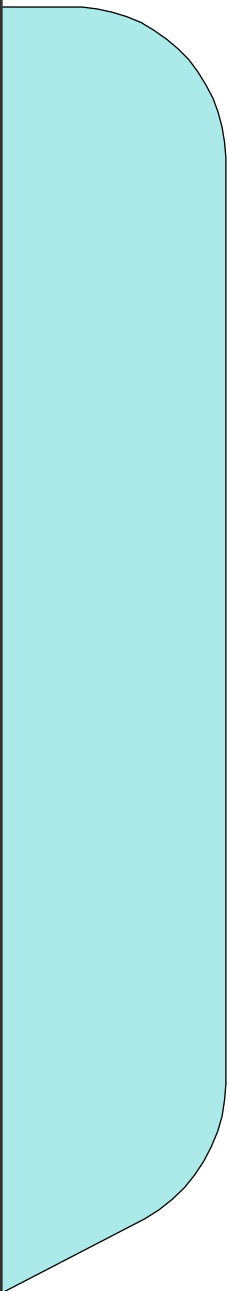

row5, col1

row5, col2

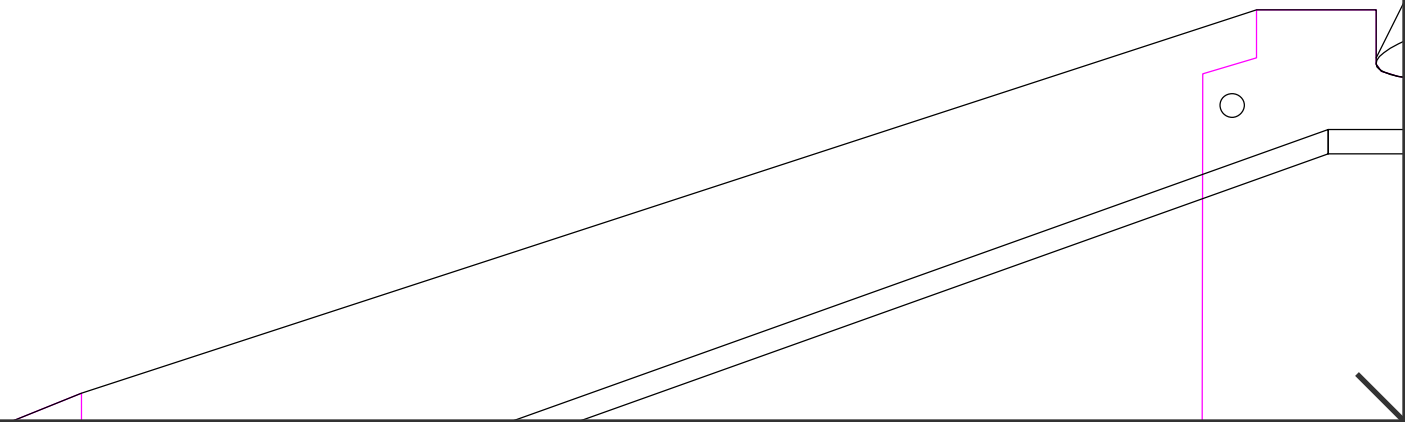

row5, col3

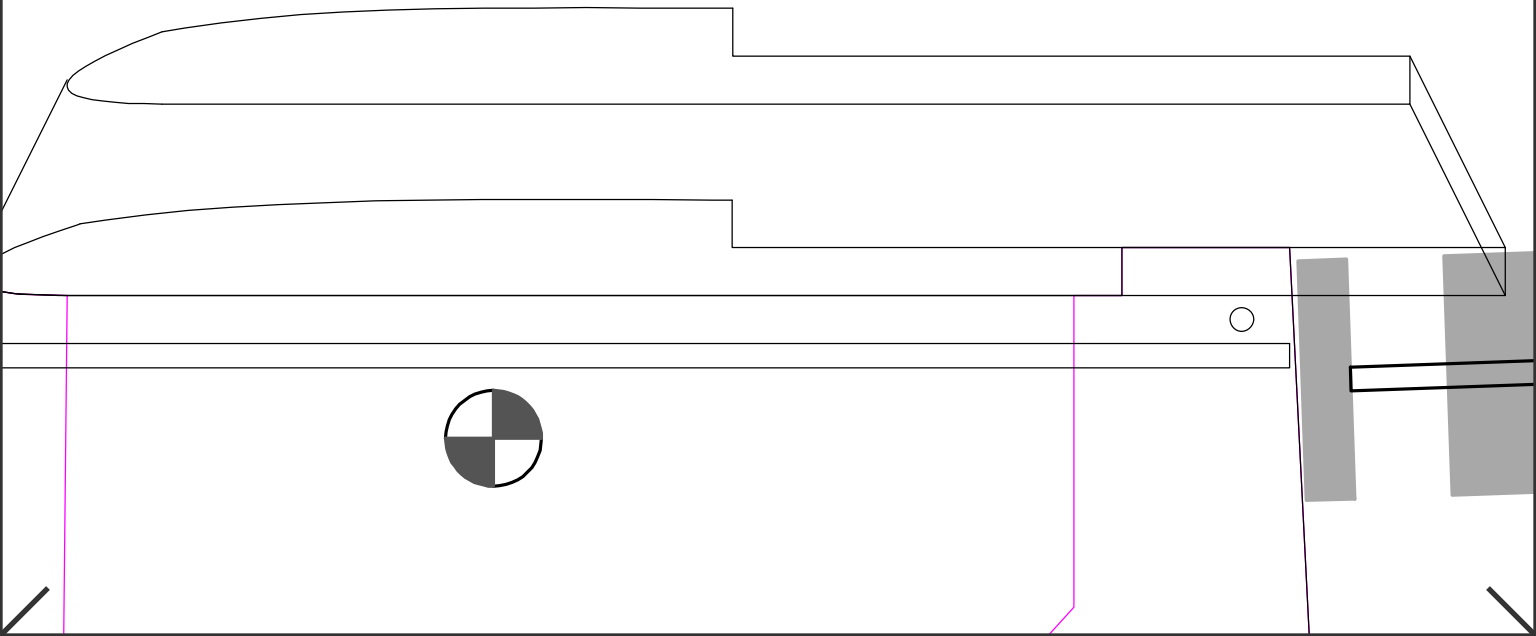
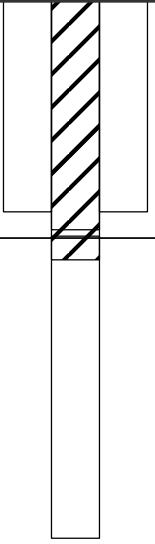

row5, col4

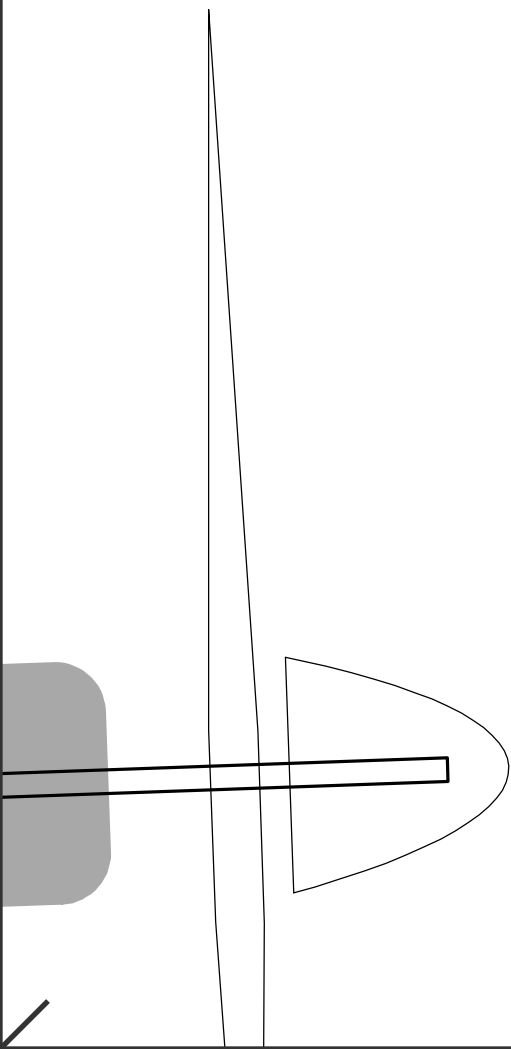

row5, col5

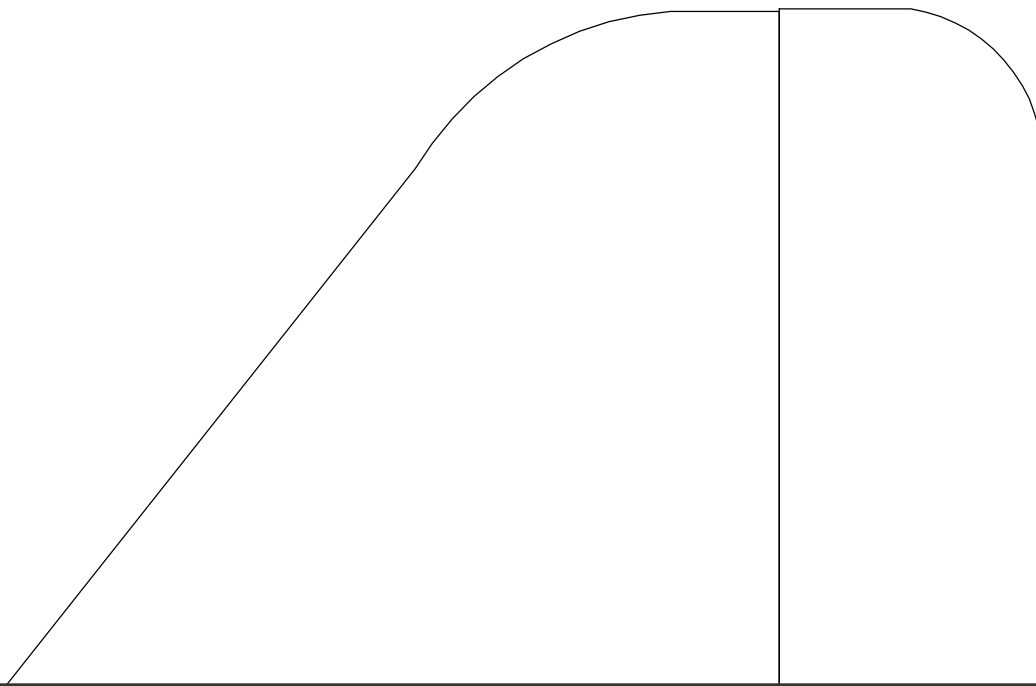

row5, col6

row5, col7

row5, col8

row5, col9

row6, col1

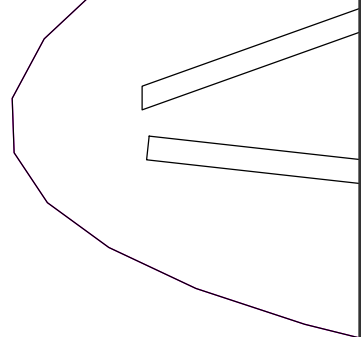

row6, col2

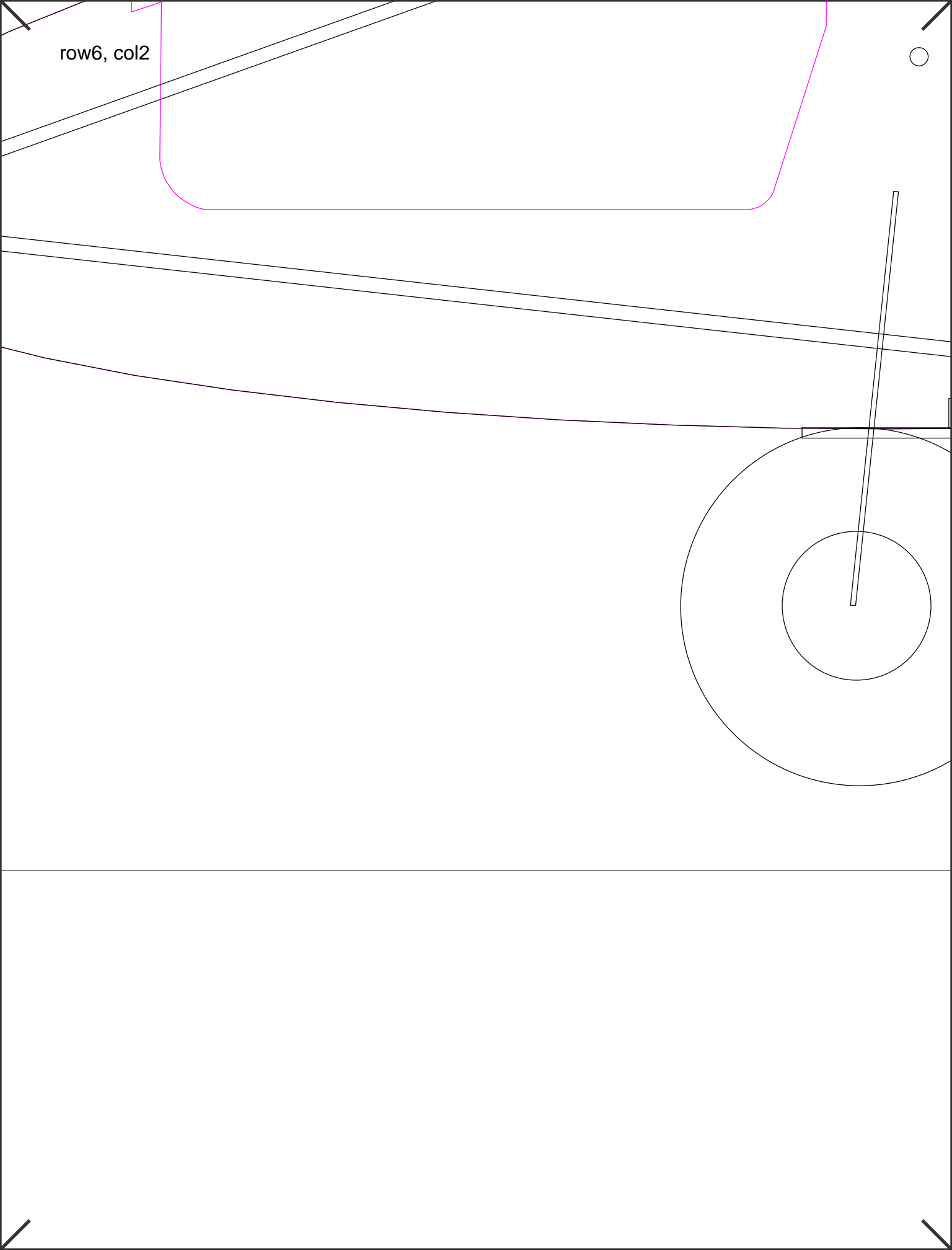
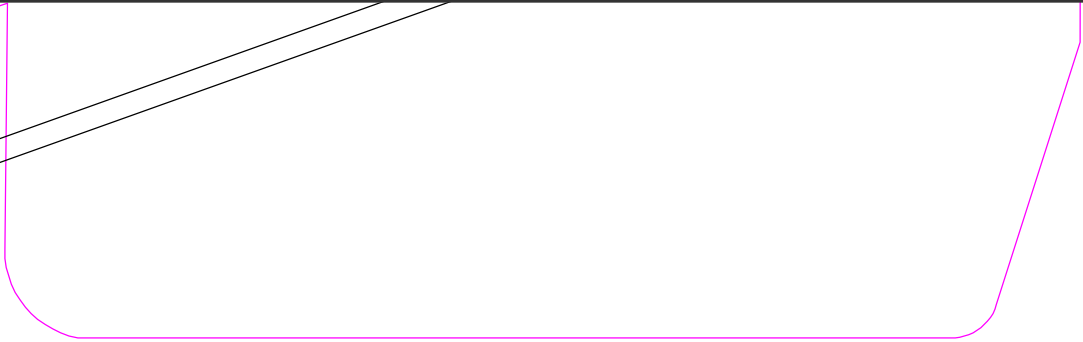

row6, col3

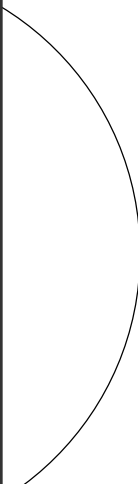
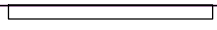
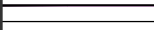
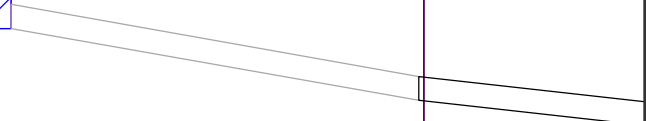
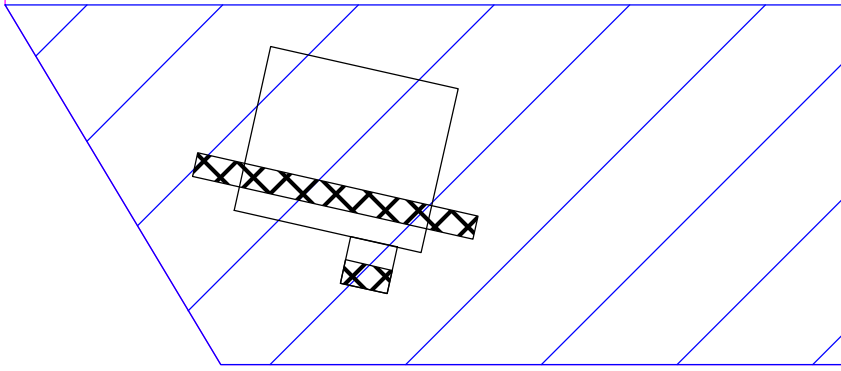

row6, col4

row6, col5

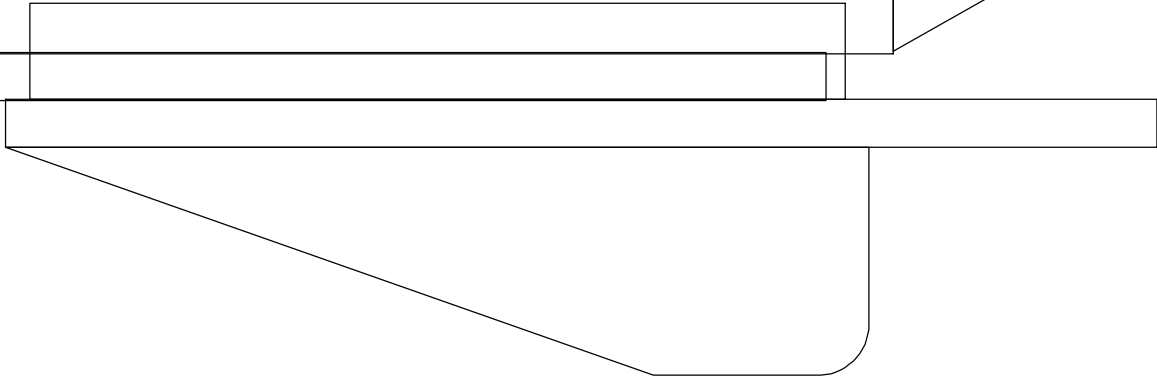

R1 C1

row6, col6

row6, col7

row6, col8

row6, col9

